

Overlay Multicast/Broadcast

- Broadcast/Multicast Introduction
- Application Layer Multicast
- Unstructured Overlays
 - Centralised
 - Distributed
- Structured Overlays
 - Flooding: CAN & Prefix Flood.
 - Tree-based:
Scribe/ SplitStream/ PeerCast
Bayeux/BIDIR-SAM
 - Additional Design Mechanisms



We need Multicast/Broadcast Services for ...

- Public Content Broadcasting
- Content Replication and Distribution
- Voice and Video Conferencing
- Collaborative Environments
- Gaming
- Rendezvous Processes / Neighbour Discovery
- Self Organisation of Distributed Systems
- ...

All of this seamless and ubiquitous!



Broadcast

- ▶ Special mode of group communication: **all nodes**
- ▶ Operates **without active participation** of nodes
 - ▶ No signalling involved
 - ▶ Simple to map to lower layers (▶ shared media)
 - ▶ Potential of increased efficiency
 - ▶ Well suited for rendezvous processes
- ▶ Results in **flooding** – typically bound to limited domains (▶ locality)



IP Multicasting

Service for Transferring IP Datagrams to Host-Groups

- Originally: RFC 1112 (S. Deering u.a., 1989)
- Addresses a host-group by means of *one* group address
- Two types of Multicast:
 - Any Source Multicast (ASM)
 - Source Specific Multicast (SSM)
- Client protocol for group membership management (IGMP/MLD)
- Internet core left with complex Multicast Routing



IP Mcast Deployment Issues

- ▶ Complexity versus Performance Efficiency
 - ▶ IP Multicast most efficient, but burdens infrastructure
- ▶ Provider Costs
 - ▶ Provisioning of knowledge, router capabilities & maintenance, Interdomain multicast routing problem
 - ▶ Business model: Multicast saves bandwidth, but providers sell it
- ▶ Security
 - ▶ ASM assists unrestricted traffic amplification for DDoS-attacks
- ▶ End-to-End Design Violation?
 - ▶ Service complexity objects implementation at lower layer
 - ▶ But for efficiency: Multicast favors lowest possible layer



Multicast: Alternative Approaches

- ▶ Application Layer Multicast (ALM)
 - ▶ Solely built with end-user systems
 - ▶ Free of any infrastructure support (except unicast)

- ▶ Overlay Multicast
 - ▶ Built on fixed nodes / proxies
 - ▶ Nodes connect to local proxies
 - ▶ Proxies responsible for routing



Application Layer Multicast

Advantages:

- Easy to deploy

Disadvantages:

- High control overhead
- Low efficiency
- Degradation by end system instability

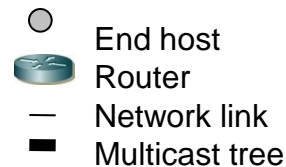
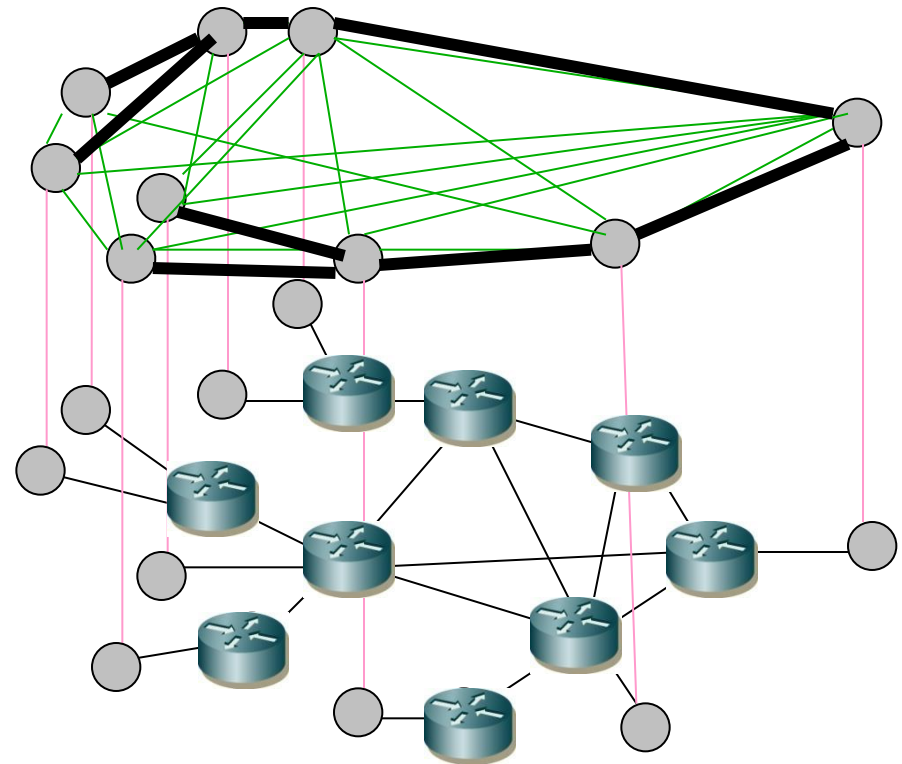

Overlay Multicast

Advantages:

- Improved efficiency in tree management
- Enhanced scalability
- Reduced control overhead

Disadvantages:

- Deployment complexity

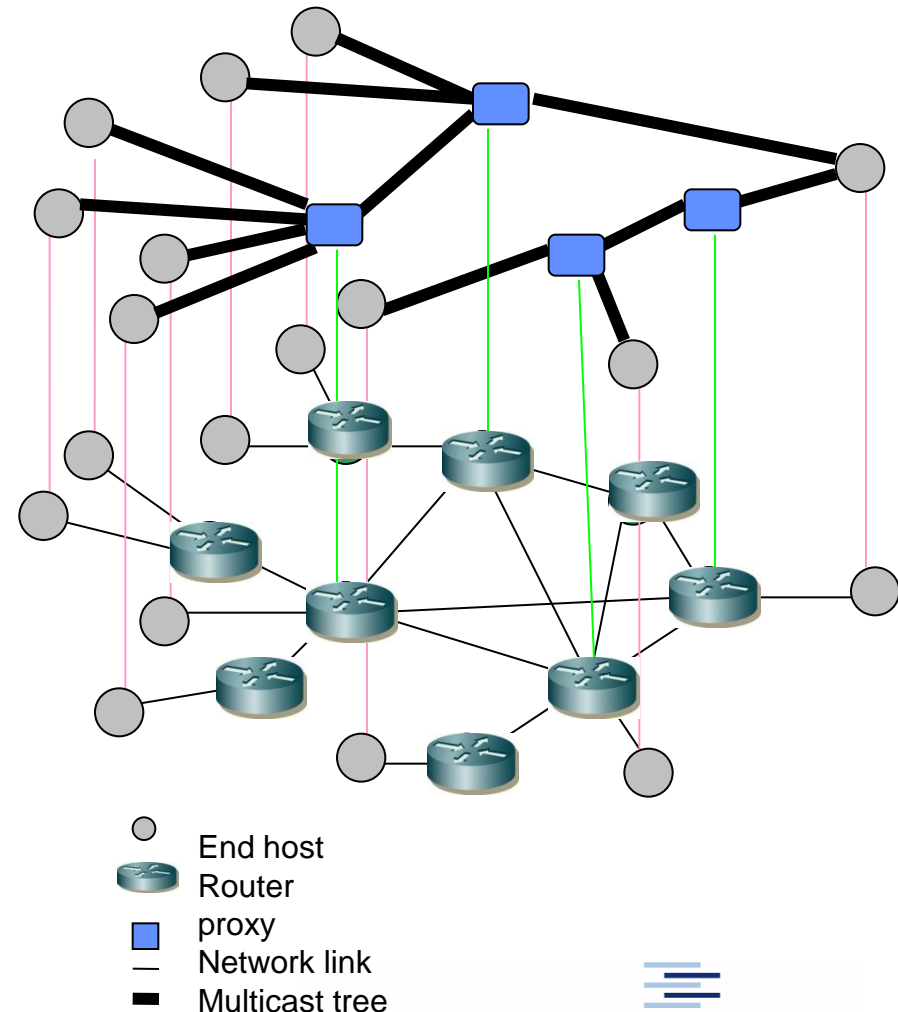

Approaches to ALM/OLM

- ▶ Mesh first
 - ▶ Group members establish an (unstructured) mesh
 - ▶ Data distribution according to **tree built on top of the mesh** or **data driven** (pull mechanism)
- ▶ Tree first
 - ▶ Group members establish a **distribution tree**
 - ▶ Sender driven (push mechanism)
- ▶ Randomized / epidemic dissemination
 - ▶ Group members broadcast to selected neighbors (Gossip)



Unstructured ALM: ALMI

- ▶ Relies on Session Controller
 - ▶ Dedicated server or group member node
 - ▶ Computes minimal spanning distribution tree
 - ▶ Assigns tree neighbours
- ▶ Controller unicasts messages per member

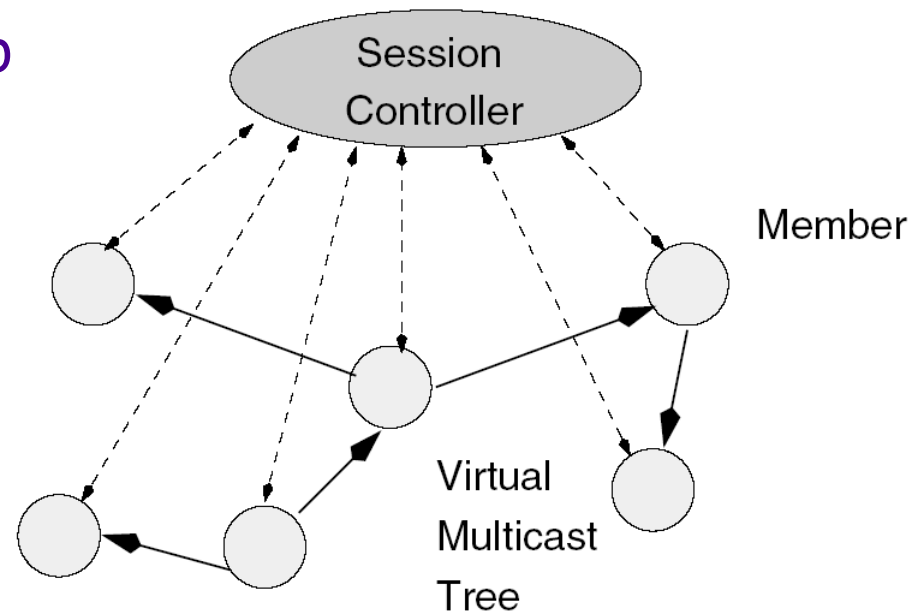

ALMI Self Organisation

Node Arrival:

- ▶ New node sends *JOIN* to controller, in response receives its ALM ID + parent location → **tree membership**
- ▶ Node submits *GRAFT* to request data from parent → **data forwarding**

Node Departure:

- ▶ Departing node sends *LEAVE* to controller, which then updates tree neighbours

Overlay Maintenance:

- ▶ Group members probe on others and report to controller



ALMI: Summary

- ▶ Early, elementary approach

PROs:

- ▶ Tree building easy adaptable to local requirements

CONs:

- ▶ Scalability and reliability problems due to centralized controller
- ▶ Scalability issue of maintenance: Mutual neighbour probing requires up to $\Theta(n^2)$ messages



Unstructured, distributed: End System Multicast/ Narada (Chu et al. 2000)

- ▶ Construct overlay tree from a mesh
 - ▶ Overlay nodes first organize in a redundantly meshed graph
 - ▶ Source specific shortest path trees then constructed from reverse paths
- ▶ Group management equally distributed on all nodes
 - ▶ Each overlay node keeps track of all group members
 - ▶ Periodic heartbeat broadcasts of all members
- ▶ Regulates node fan-out degree to balance load



Narada Components

► Mesh Management:

- Ensures mesh remains connected in face of membership changes

► Mesh Optimization:

- Distributed heuristics for ensuring shortest path delay between members along the mesh is small

► Spanning tree construction:

- Routing algorithms for constructing data-delivery trees
- Distance vector routing, and reverse path forwarding
- Discovery and tree building analogue to DVMRP



Optimizing Mesh Quality

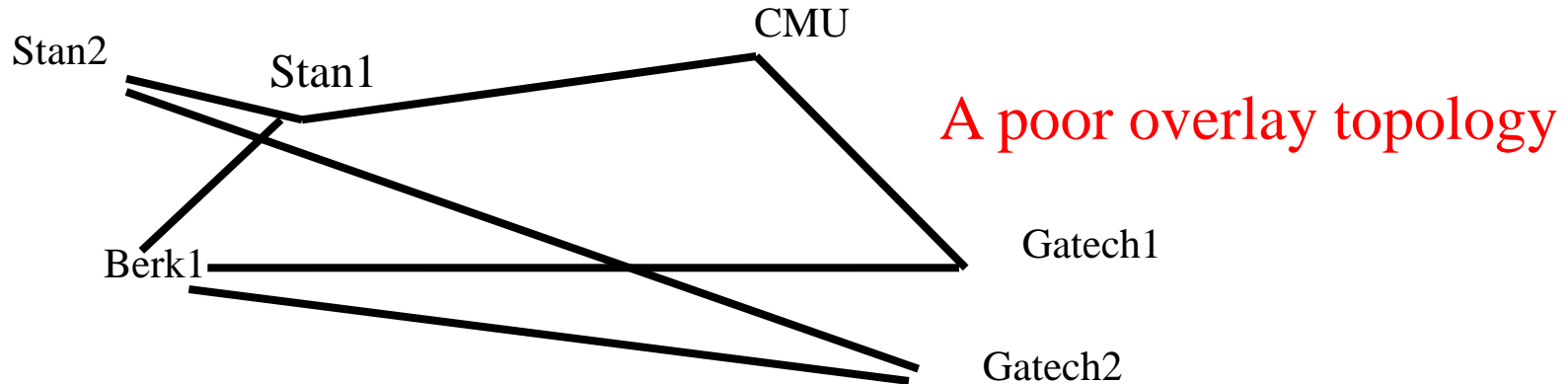

- Members periodically probe other members at random

- New Link added if

Utility Gain of adding link $>$ Add Threshold

- Members periodically monitor existing links

- Existing Link dropped if

Cost of dropping link $<$ Drop Threshold



Desirable properties of heuristics

- **Stability:** A dropped link will not be immediately readded
- **Partition Avoidance:** A partition of the mesh is unlikely to be caused as a result of any single link being dropped

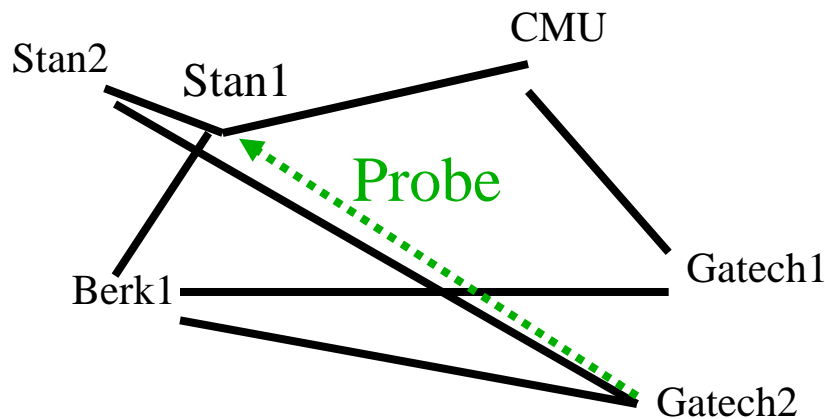

Delay improves to Stan1, CMU but marginally.

Do not add link!

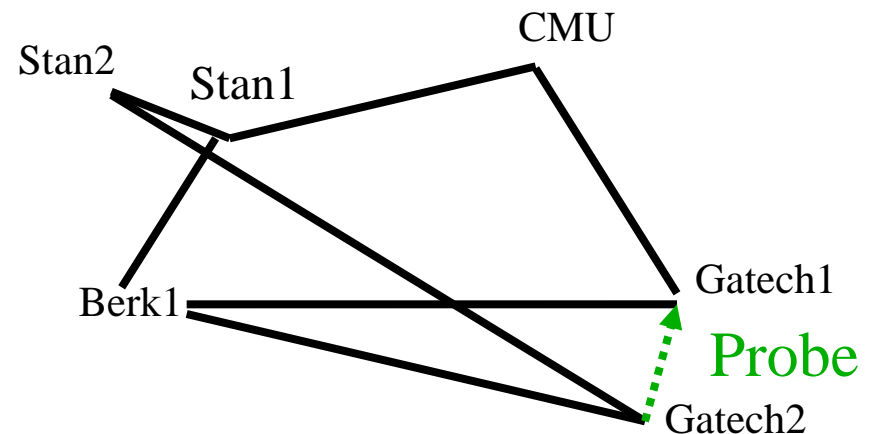

Delay improves to CMU, Gatech1 and significantly.

Add link!



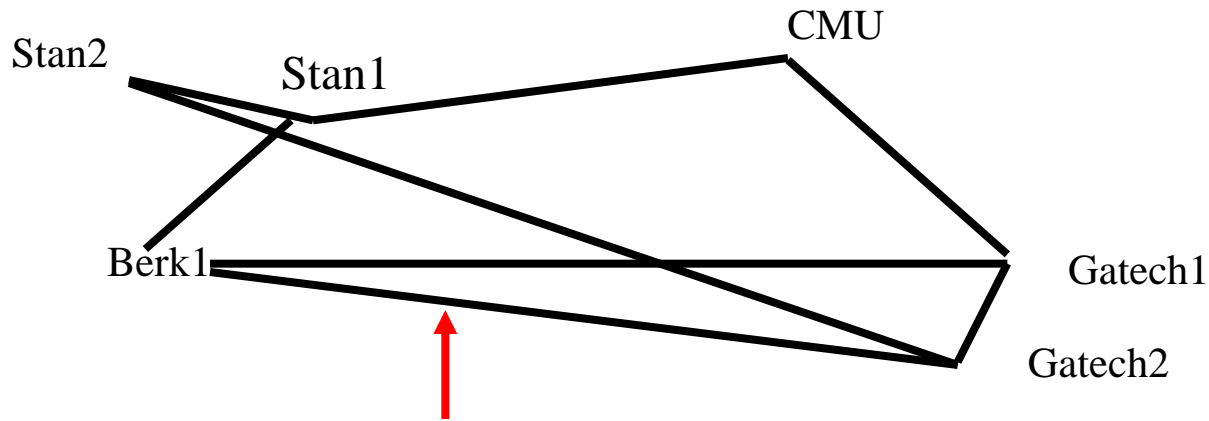

Used by Berk1 to reach only Gatech2 and vice versa.

Drop!!

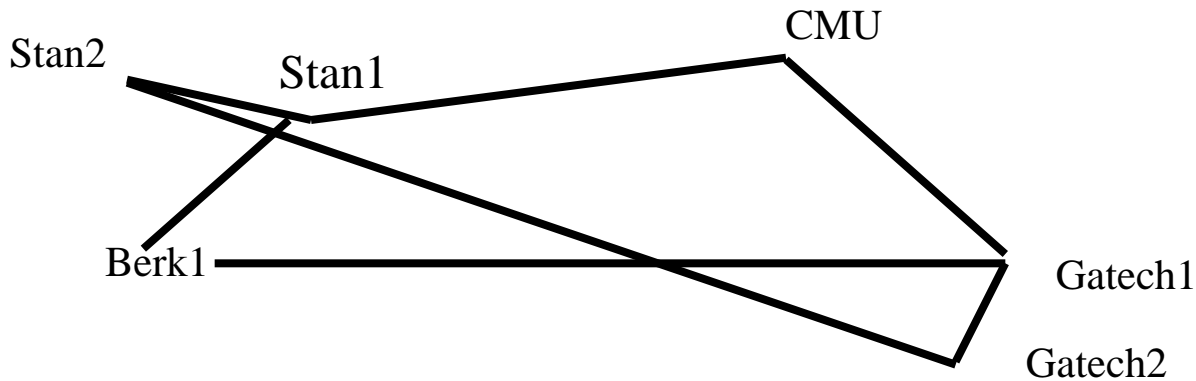

An improved mesh !!



Evaluation: Relative Delay Penalty

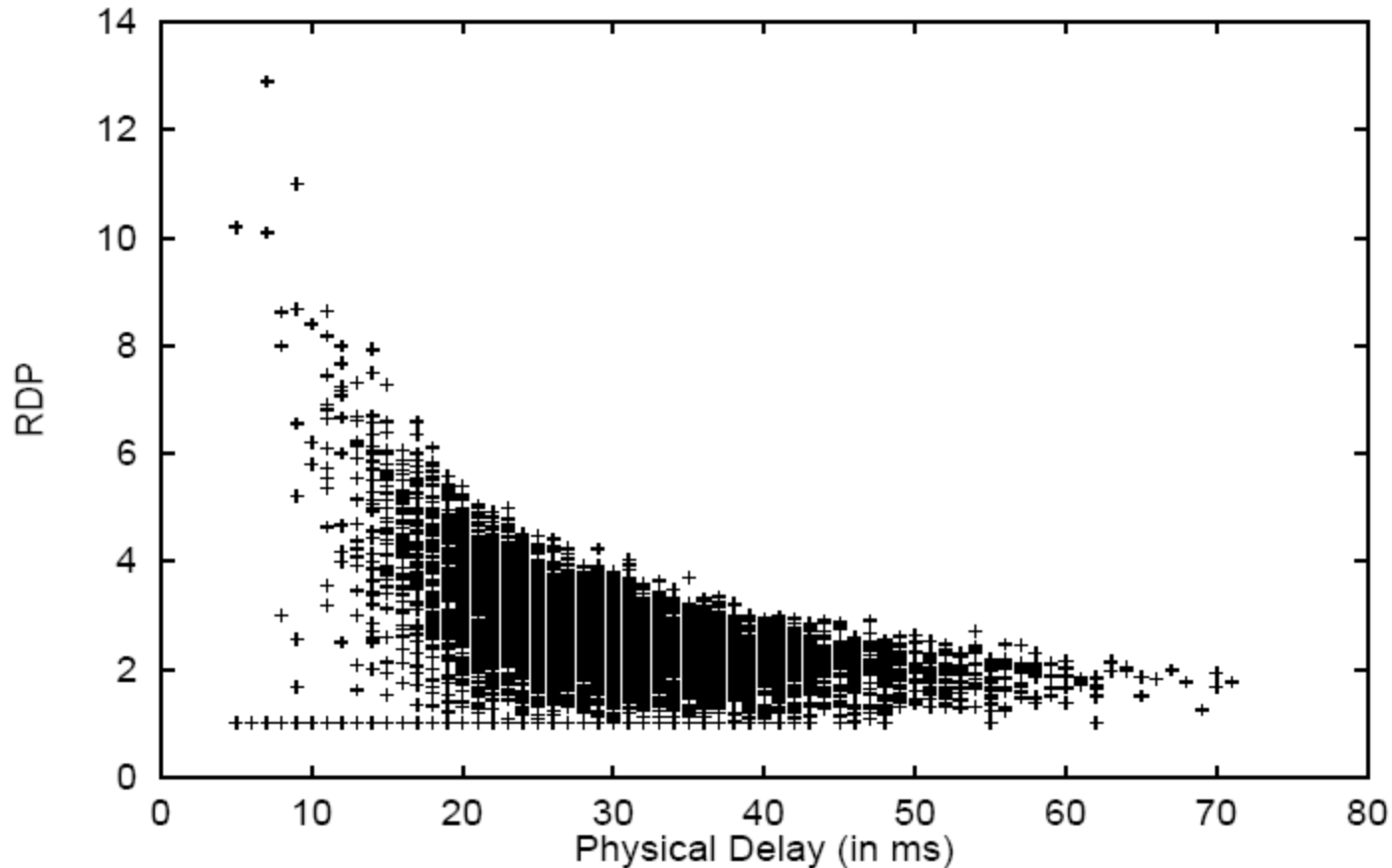

128 Group Members within 1024 Nodes with 3145 Links



Narada Summary

- ▶ Elementary mesh-centric approach
 - ▶ Topology inherited from mesh management

PROs:

- ▶ Mesh organization easily adapts to underlay characteristics
- ▶ Decentralized group management, independent of individual nodes
- ▶ Fan-out adaptation

CONs:

- ▶ Meshes do not adapt well to proximate environments
- ▶ Flooding & pruning inefficient, but required whenever mesh changes
- ▶ Scalability issues in group management: Heartbeat and tracking required



Unstructured Scalable: NICE (Banerjee et al. 2002)

- ▶ Cluster-based approach: topologically close nodes are combined in clusters of approx. equal size
- ▶ Hierarchies are formed from clusters:
 1. All nodes are in some cluster at layer 0
 2. Each cluster determines a leader, leaders form next layer
 3. Layered clustering continues until leader set sizes match cluster size
 4. Last leader is root
- ▶ Cluster-Hierarchy generates trees



Cluster to Tree

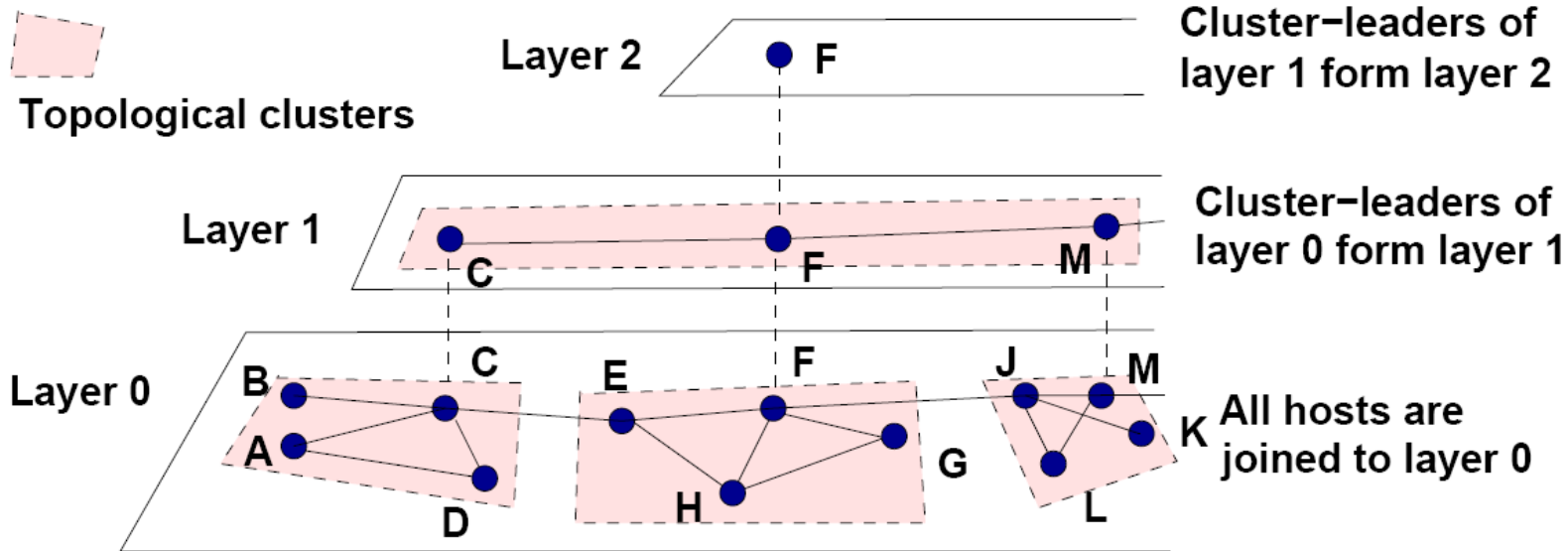

Control- and data forwarding trees (source-specific shared trees):

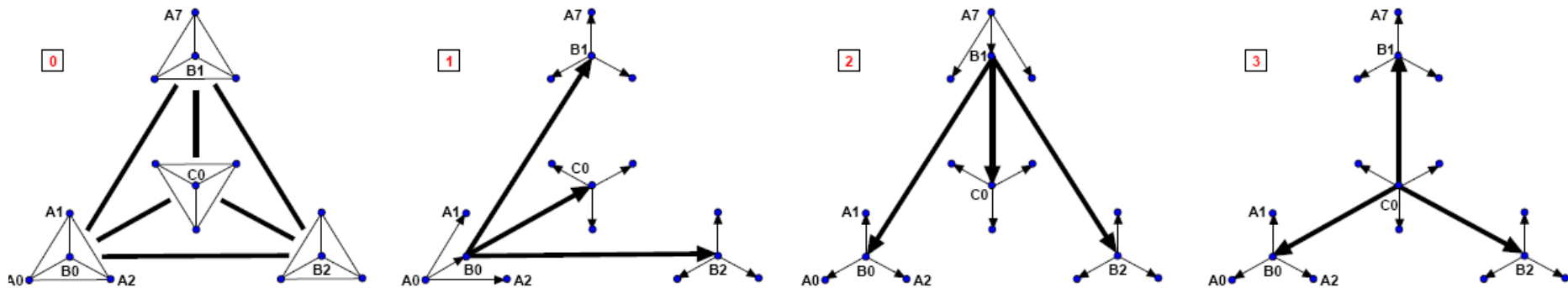

Group Management

- ▶ One cluster hierarchy per group, a well known RP is assumed
- ▶ Joining node contacts RP and learns root node
- ▶ Joining node descends hierarchy to find appropriate cluster in layer 0

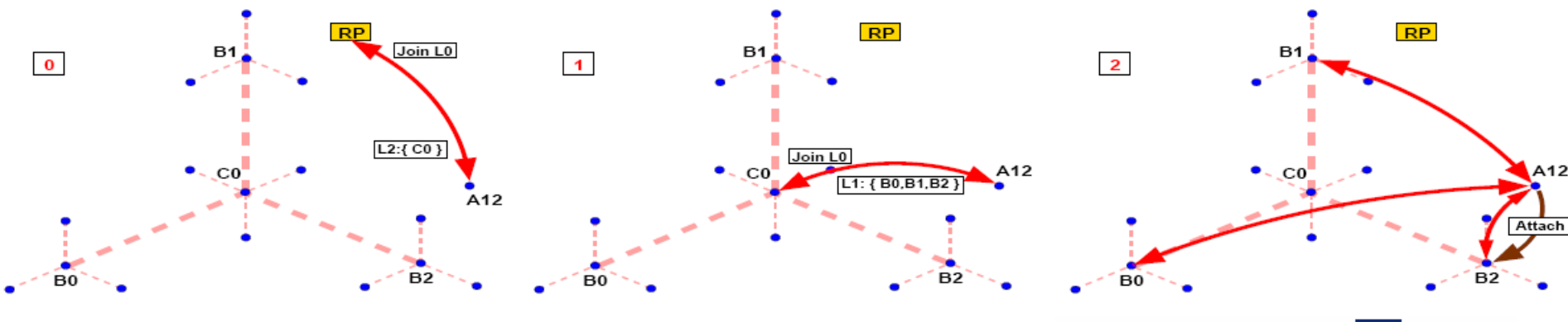

Nice Performance

Cumulative distribution of data path lengths after overlay stabilizes

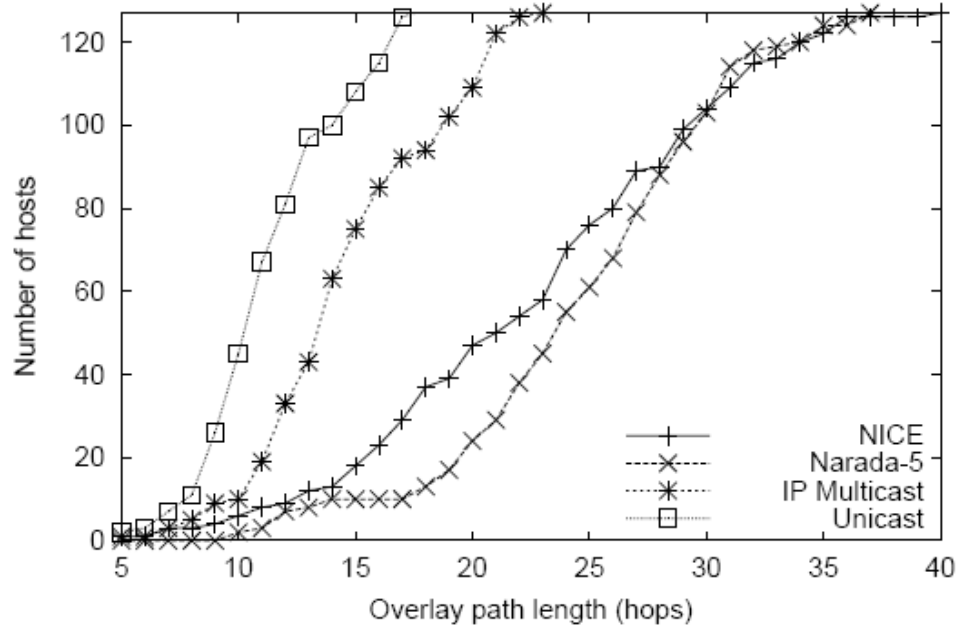

Control traffic bandwidth at the access links

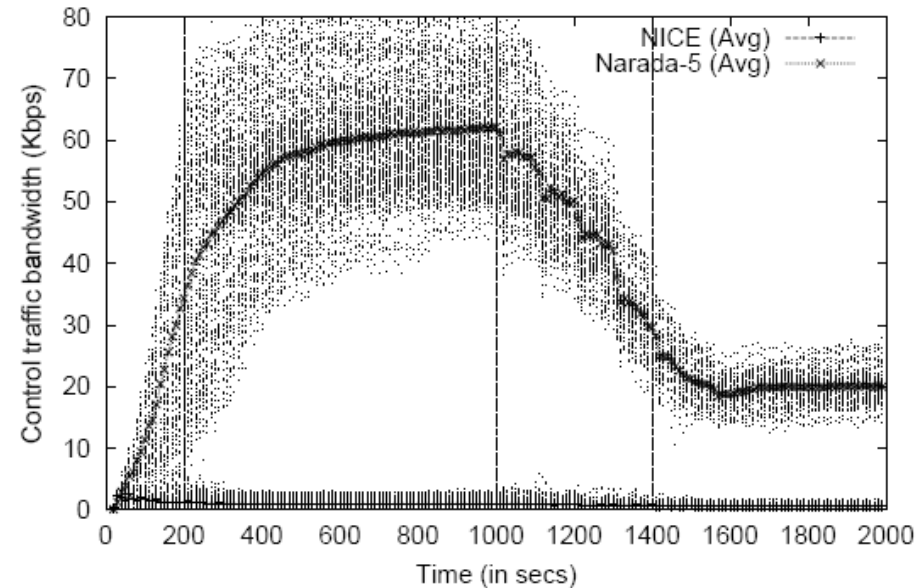

Nice Summary

- ▶ Unstructured cluster-centric approach
 - ▶ Topology reflected by clusters

PROs:

- ▶ Scales logarithmically in hops and control overhead
- ▶ Replication load (fan-out) bound by a constant
- ▶ Constant state per node

CONS:

- ▶ Topological knowledge is assumed, as well as known RP
- ▶ Clusters need maintenance after node arrival and departure



Structured Overlay Multicast

- ▶ Flooding-based approaches
 - ▶ Packet broadcasts within a structured overlay
 - ▶ Selective broadcast (multicast) by group-specific DHT
 - ▶ Multicast on CAN & Prefix Flooding
- ▶ Tree-based approaches
 - ▶ Shared trees: Routing via group-specific rendezvous point
 - ▶ Scribe/Splitstream
 - ▶ Source-specific trees: Construction of source-specific shortest path trees after source announcements
 - ▶ Bayeux, BIDIR-SAM



Multicast on CAN (Ratnasamy et al 2001)

- ▶ Within a previously established CAN overlay members of a Group form a “mini” CAN
 - ▶ Group-ID is hashed into the original CAN
 - ▶ Owner of the Group key used as bootstrap node
- ▶ Multicasting is achieved by flooding messages over this mini CAN
- ▶ Number of multicast states is limited by $2d$ neighbours – independent of multicast source number!
- ▶ Can Multicast scales well up to very large group sizes
 - ▶ Replication load limited to neighbours ($2d$)
 - ▶ But tends to generate packet duplicates



Improved Flooding

- ▶ Source of a messages forwards it to all neighbours
- ▶ Receiver of a message (from dimension i) only forwards along dimensions lower than i and along i in opposite direction
- ▶ A node does not forward to a dimension, where the message has already travelled half way from source coordinate
- ▶ Nodes cache sequence numbers already forwarded to prevent duplicate forwarding



Can Forwarding

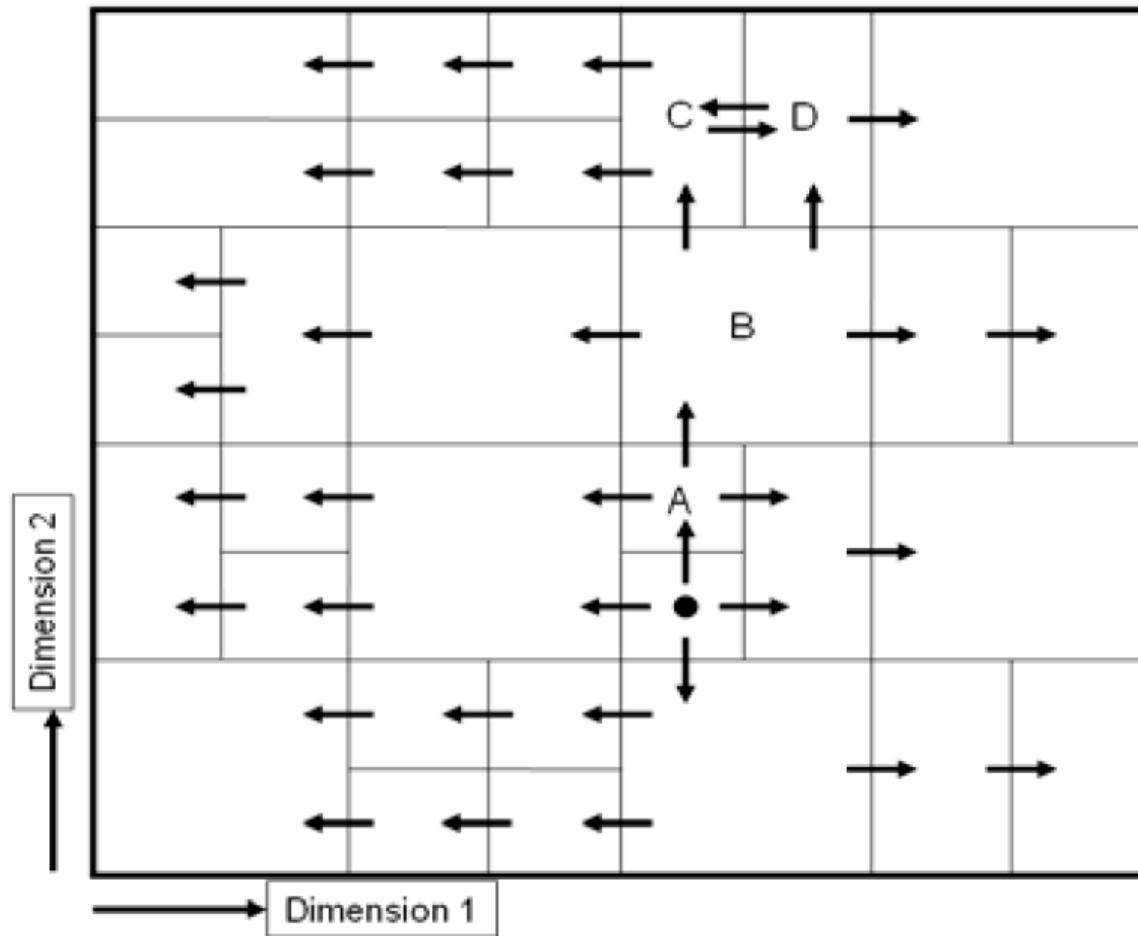

Forwarding in Idealized CAN

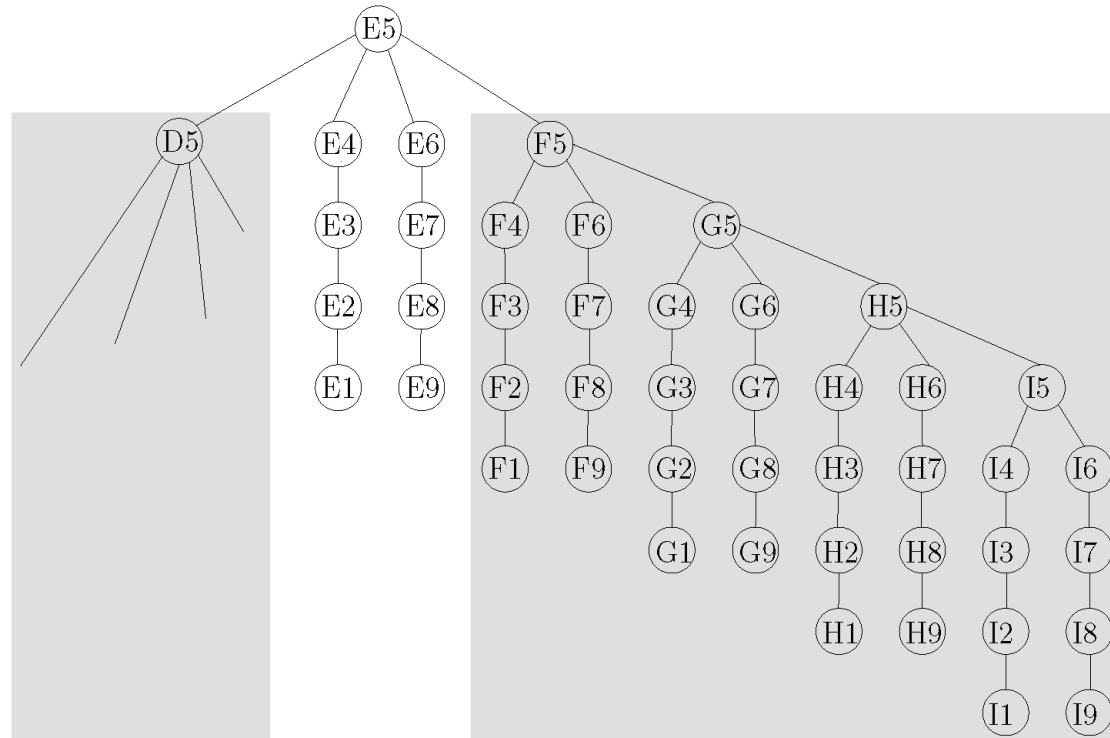
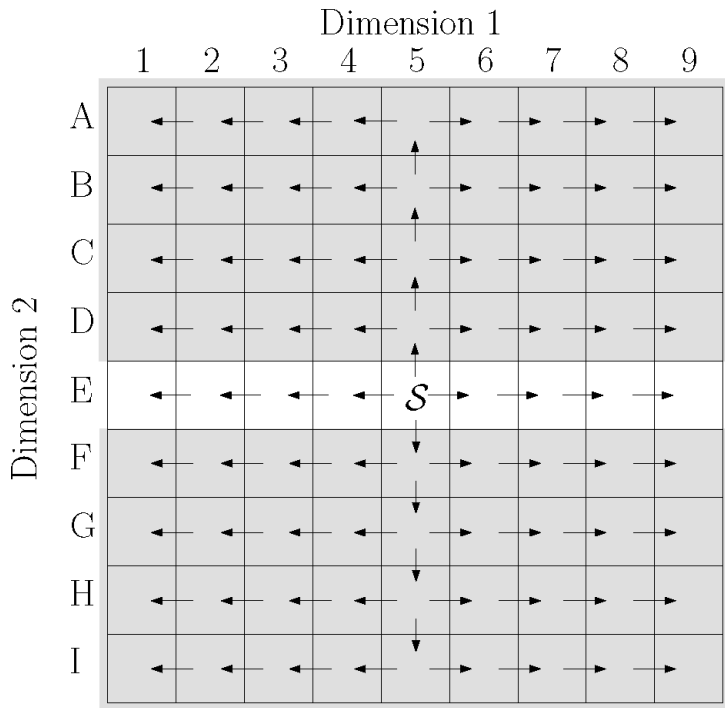

Even HyperCube

Corresponding Tree



Evaluation: Relative Delay Penalty

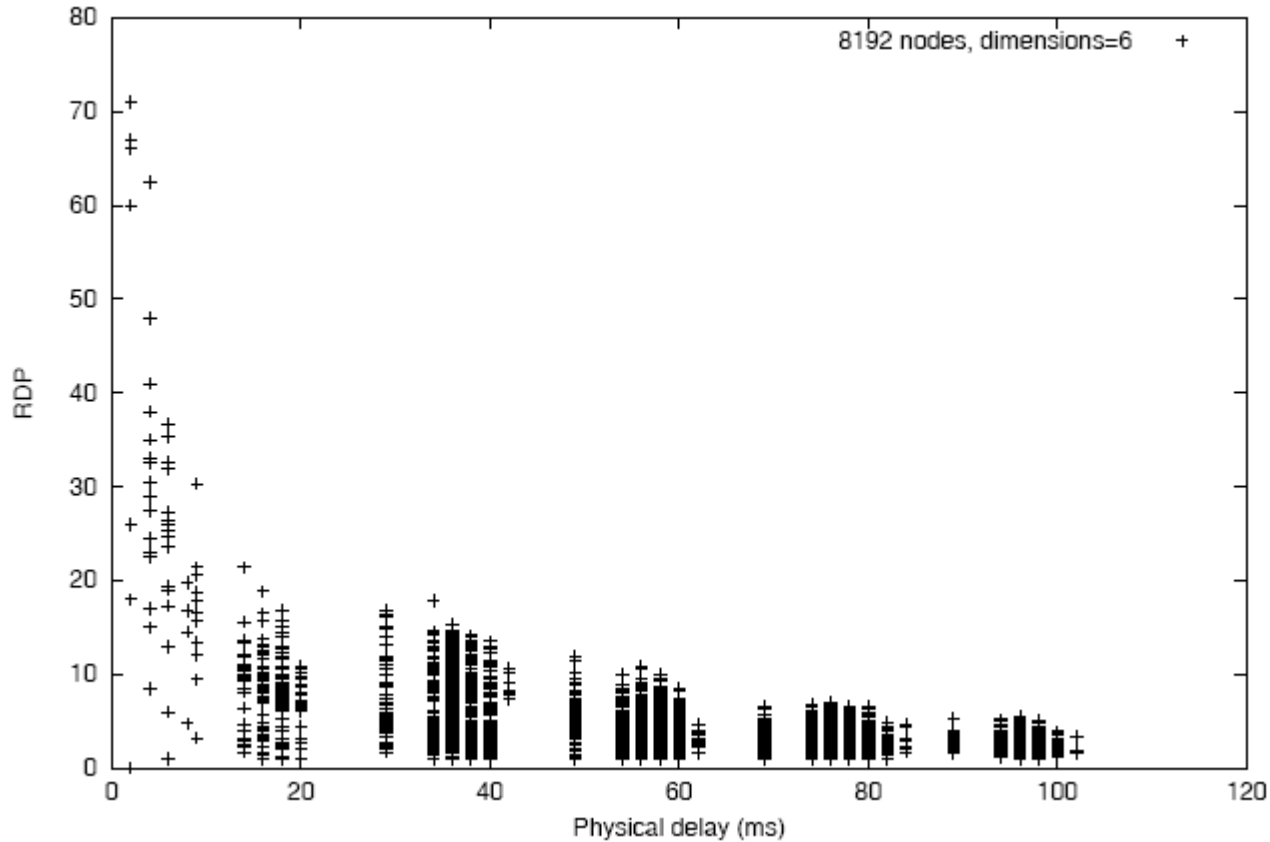

Hopcount Distribution

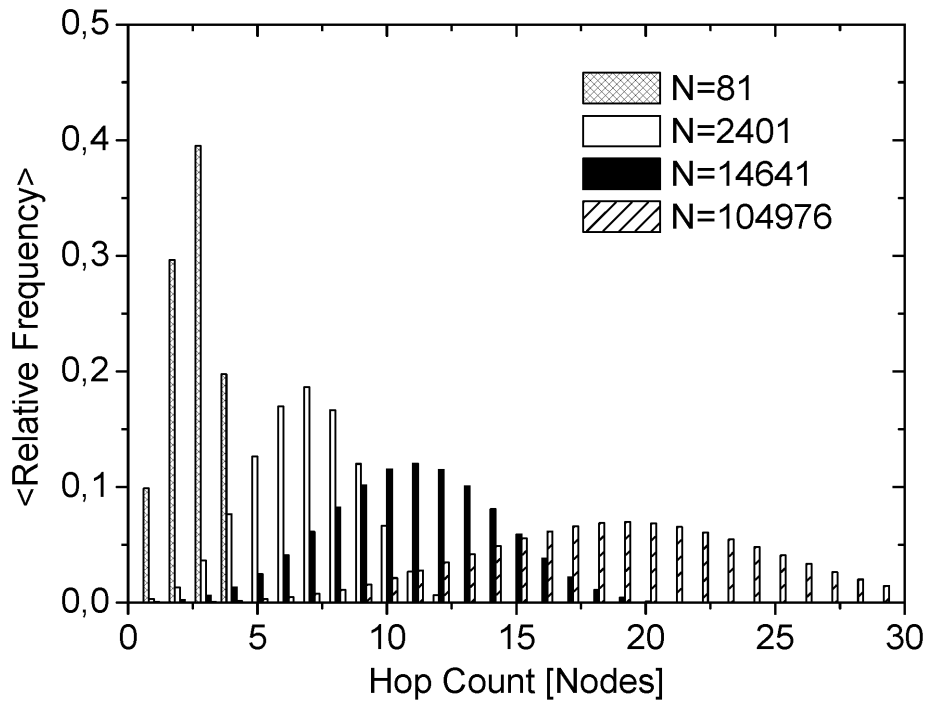

Dimension = 4

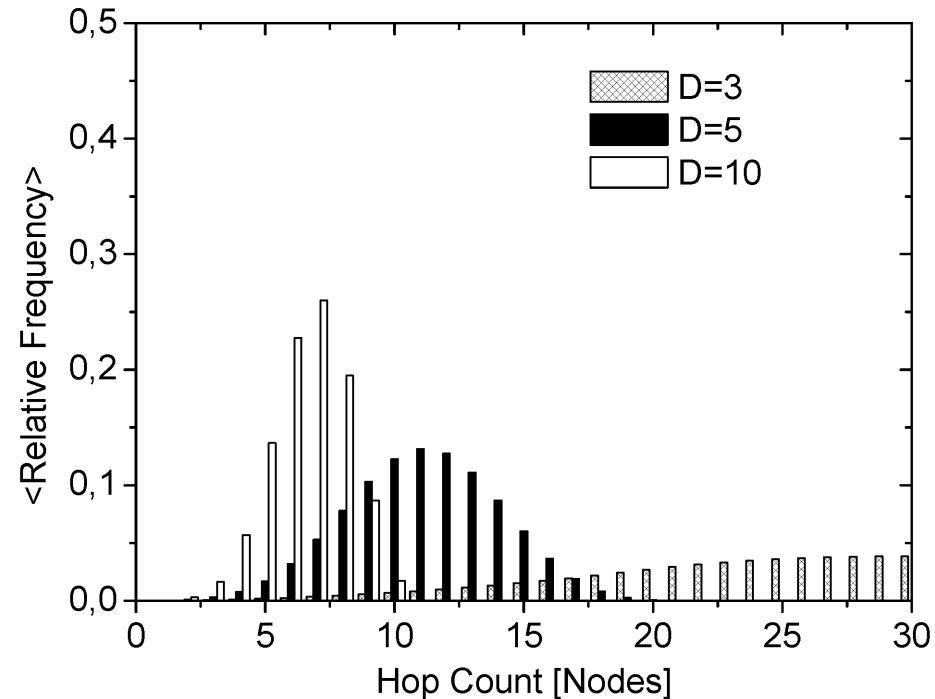

Network Size = 59049



Replication Load

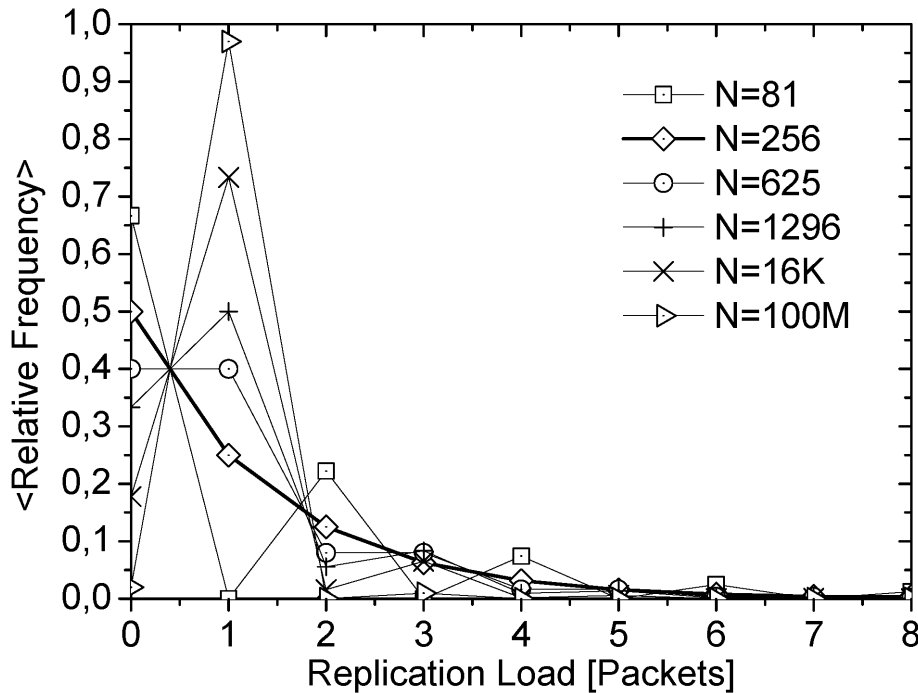

Dimension = 4

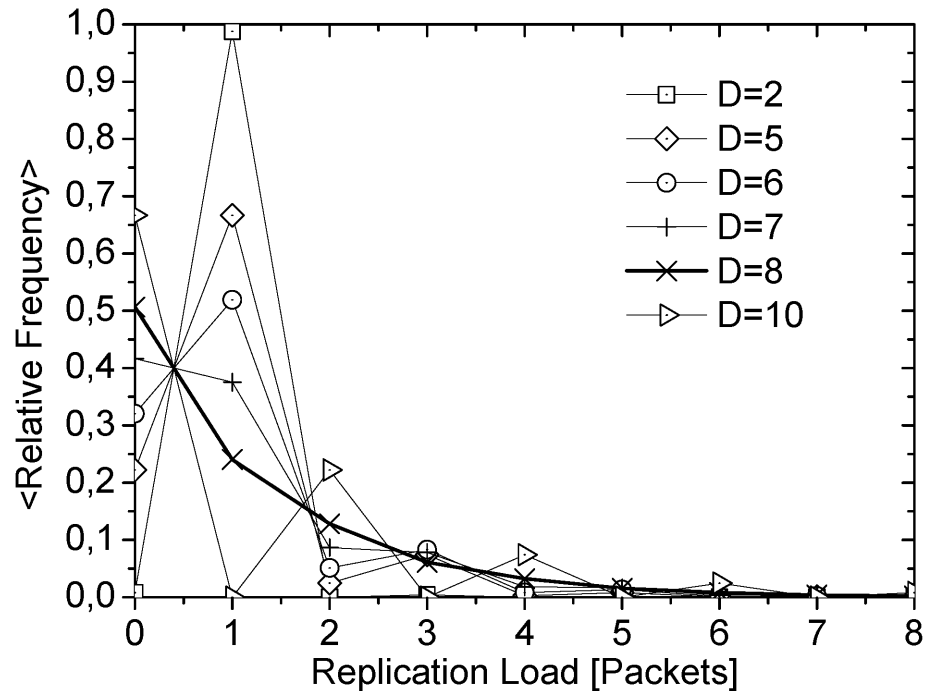

Network Size = 59049



Prefix Flooding

- DHT Nodes are identified by hash codes
- Idea:
 - Arrange IDs in a prefix tree
 - Flood prefix neighbours (w.r.t. longest common prefix - LCP)
- Defines broadcast for any DHT, Multicast per mini-DHT analogue to CAN
- Packet delivery unique: no duplicates
- Particularly well suited for proximity-aware prefix routing like in Pastry

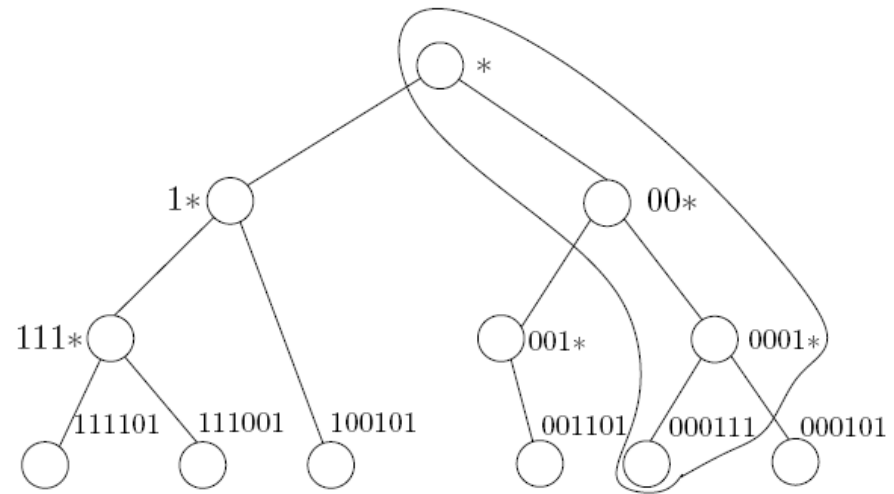

Prefix Flooding Algorithm

Routing requires:

- ▶ Destination prefix \mathcal{C} for on-tree context
- ▶ Proactive routing maintenance: prefix neighbour entries needed for forwarding

PREFIX FLOODING

- ▷ On arrival of a packet with destination prefix \mathcal{C}
- ▷ at a DHT node

```
1  for all  $\mathcal{N}_i$  IDs in prefix neighbor set
2      do if ( $LCP(\mathcal{C}, \mathcal{N}_i) = \mathcal{C}$ )  ▷  $\mathcal{N}_i$  dntree neighbor
3          then  $\mathcal{C}_{new} \leftarrow \mathcal{N}_i$ 
4              FORWARD PACKET TO  $\mathcal{C}_{new}$ 
```



Analysis of Prefix Flooding

- Structural analysis relatively simple due to the recursive nature of k-ary trees
- Distinguish between fully and sparsely populated tree

Closed expressions for:

- Replication Load
- Hop Count

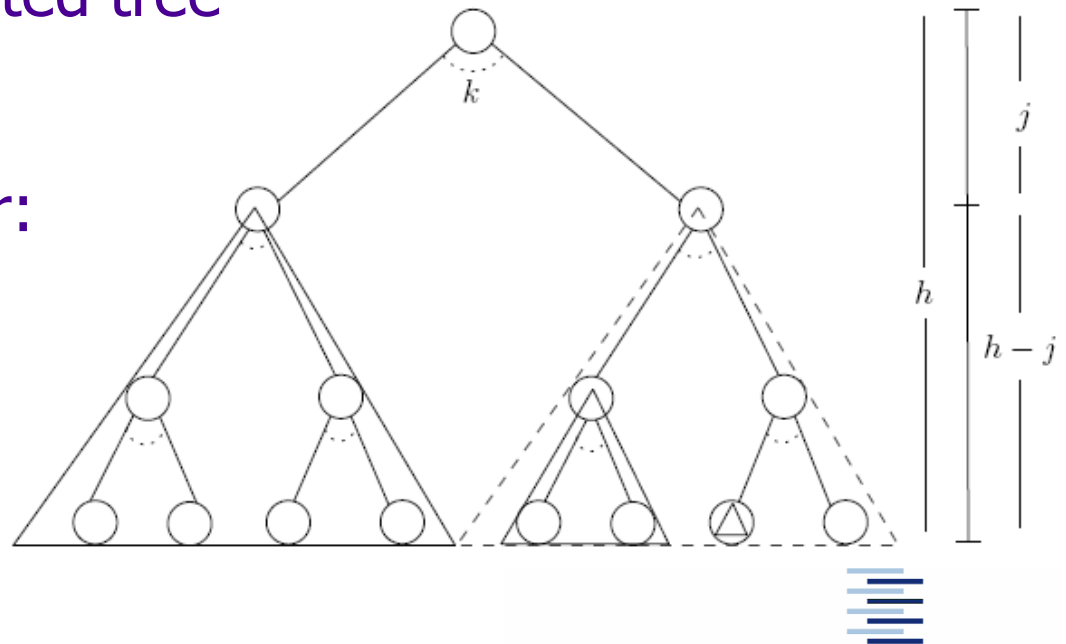

Performance Values

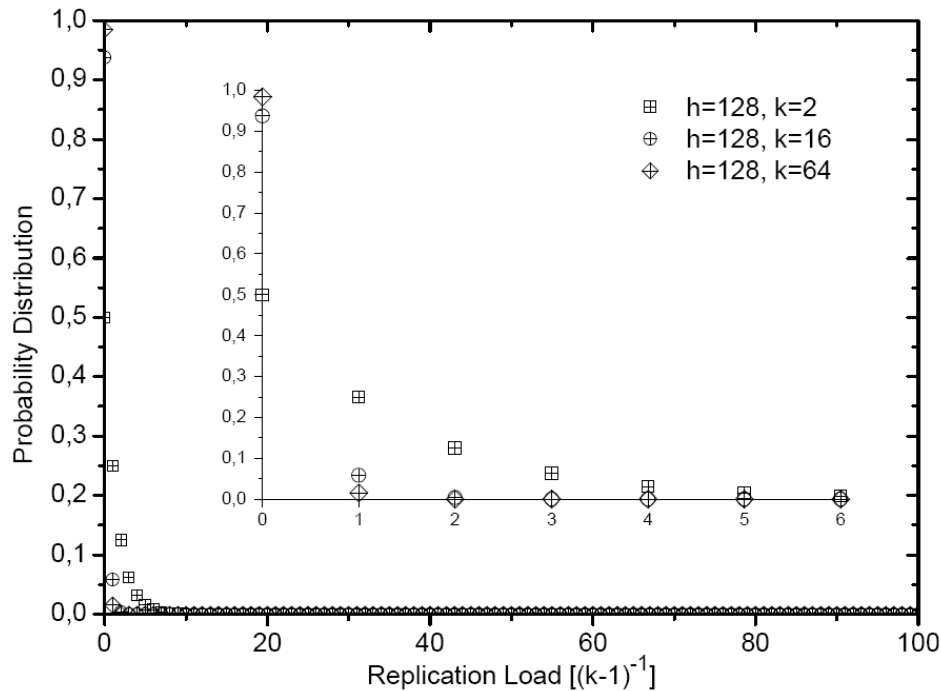

p is sparseness parameter

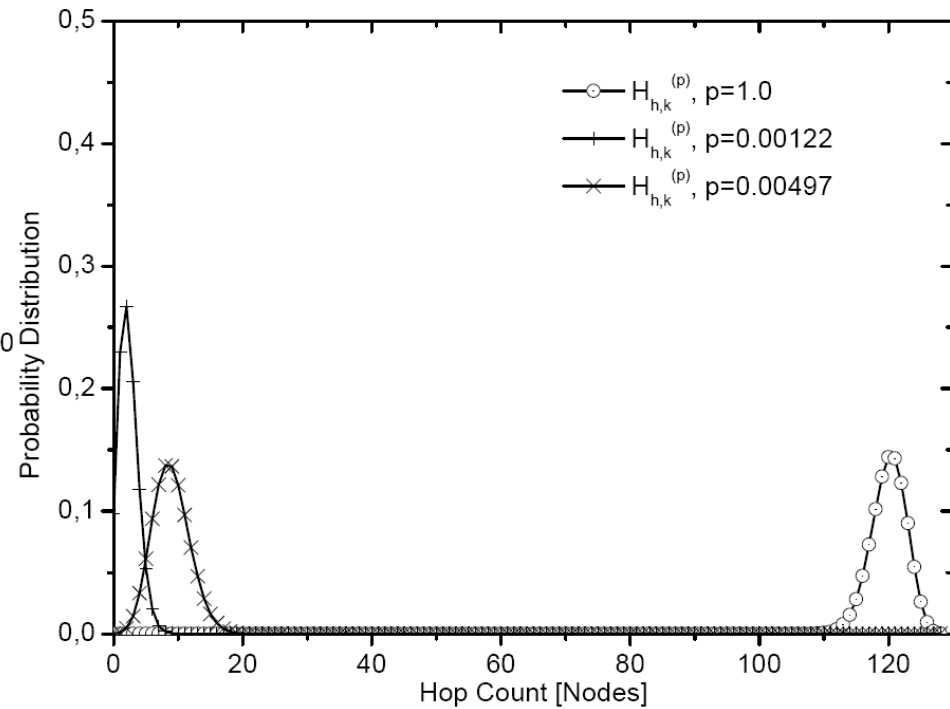

Summary on Flooding Approaches

- ▶ Defines a natural broadcast mechanism on the KBR
 - ▶ Transparent for sources & receivers:
no signalling, no additional states
 - ▶ Problem of CAN: Duplicates & efficiency,
solved with Prefix Flooding over Pastry
- ▶ Multicast requires construction of sub-DHTs
 - ▶ Group management based on DHT membership
management
 - ▶ Tedious & slow – high overheads when updating
routing tables



Shared Distribution Tree: Scribe (Castro et al 2002)

- ▶ Large-scale distribution service based on Pastry
- ▶ Rendezvous Point chosen from Pastry nodes
 - ▶ Choice according to group key ownership
 - ▶ RP roots shared distribution tree (analogue PIM-SM)
- ▶ Shared tree created according to reverse path forwarding
 - ▶ Nodes hold *children tables* for forwarding
 - ▶ New receiver routes a *SUBSCRIBE* towards the RP
 - ▶ *Subscribe* intercepted by intermediate nodes to update children table, reverse forwarding done, if node not already in tree



Scribe API

- ▶ **Create (credentials, topicID):** Creates a group identified by a unique topicID (hash of textual description+creatorID), credentials administrative
- ▶ **Subscribe (credentials, topicID, eventHandler):** Initiates a local join to group, asynchronously received data passed to the eventHandler
- ▶ **Unsubscribe (credentials, topicID):** Causes a local leave of group
- ▶ **Publish (credentials, topicID, event):** Multicast source call for submitting data (event) to group



Scribe Tree Construction

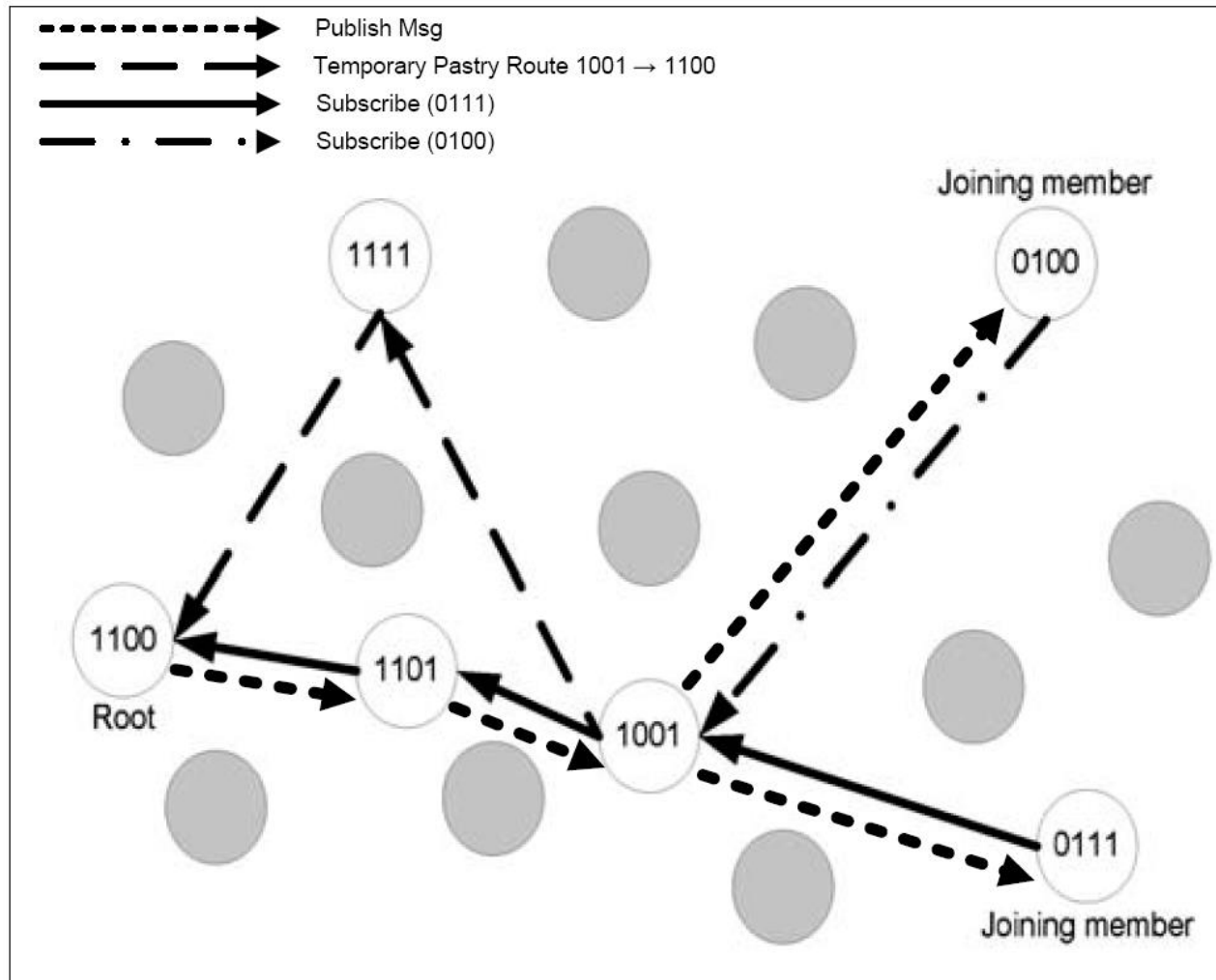

Can versus Scribe: Delay Penalty

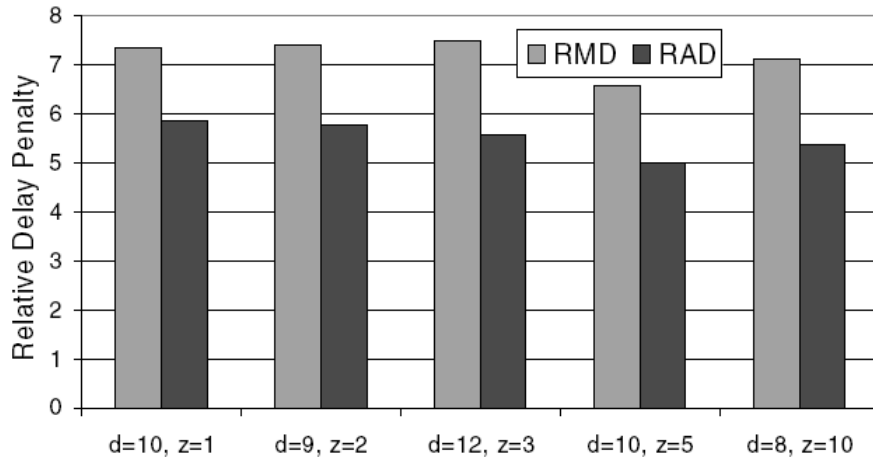

(a) CAN

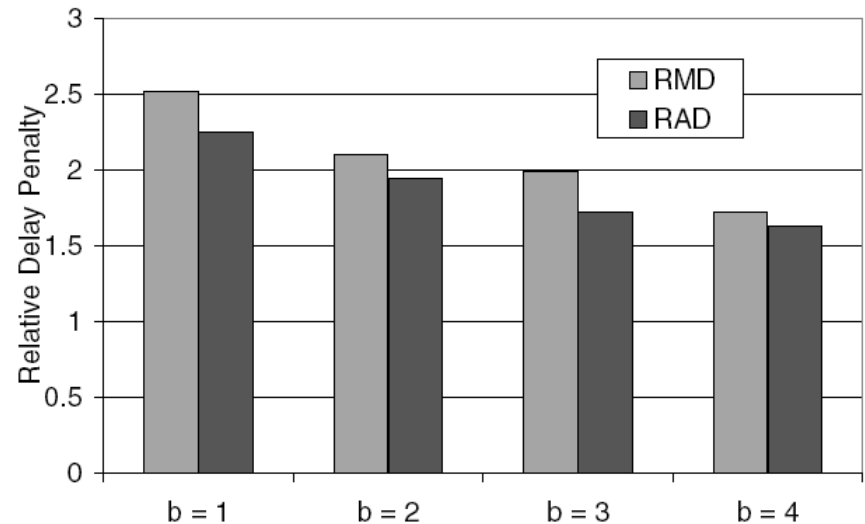

(b) Scribe

RMD: Relative Delay Maximum

RAD: Relative Average Delay

CAN may be configured to provide higher network efficiency



Scribe Performance: Hop Count

- ▶ Simulation in OverSim network simulator
- ▶ 1.000 Pastry nodes
- ▶ Hop Count evaluated for varying group sizes

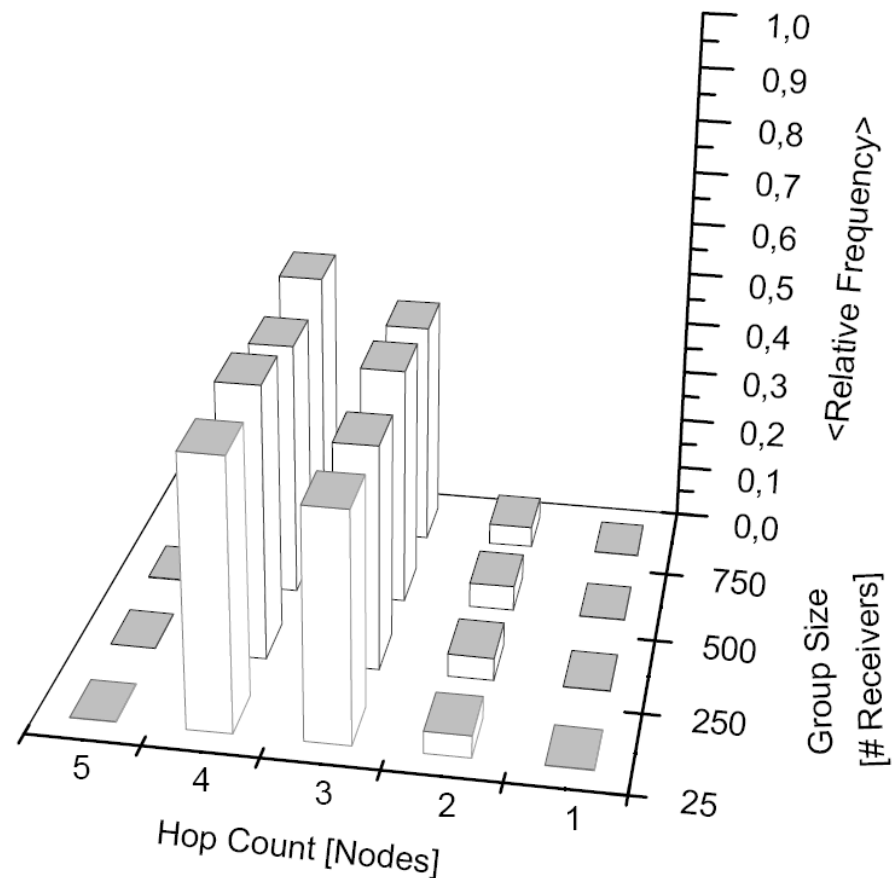

Tree Characteristics in Scribe

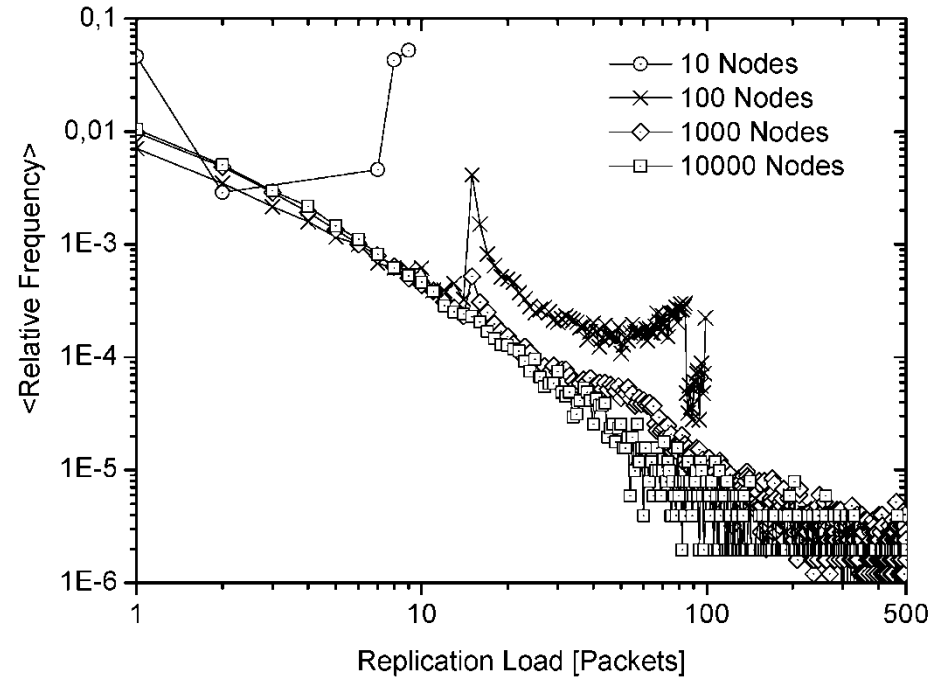
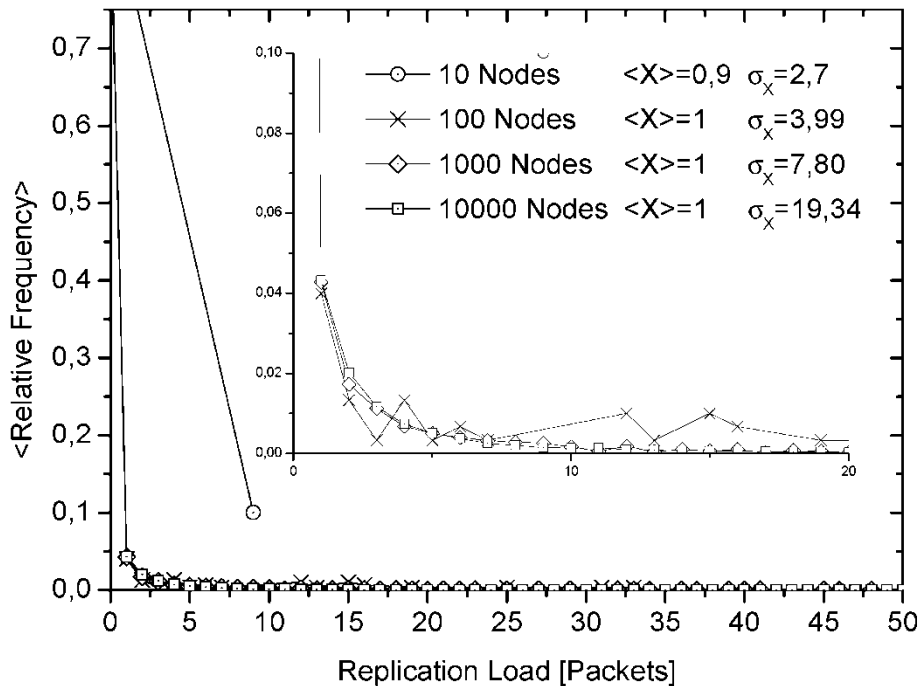

- ▶ Almost all branches arise from Rendezvous Point
- ▶ Scribe foresees „manual“ load balancing



Improvement: SplitStream (Castro et al. 2003)

- ▶ Focus on media data distribution
- ▶ Idea: Split media streams into slices and distribute sliced streams via disjoint trees
- ▶ Disjoint trees created by modifying prefix initial
 - ▶ Pastry leads to disjoint prefix routes
 - ▶ Scribe distribution trees according to prefix routes
 - ▶ All group members are leaves in all trees
- ▶ Accounts for member bandwidth constraints
- ▶ Problem: Jitter explosion



Summary on Scribe/SplitStream

- ▶ Conventional approach to build ASM shared trees on the KBR (Key-based routing) layer

PROs

- ▶ Autonomous identification of RP via keyspace
- ▶ Efficient group and tree management

CONS

- ▶ Distribution trees lack efficiency because of the RP triangle and RPF at asymmetric unicast routing
- ▶ Highly unbalanced replication load at nodes
- ▶ High delay and jitter values



PeerCast (Zhang et al. 2004)

- ▶ Multicast distribution service enhancing SCRIBE
 - ▶ Variation of PASTRY
 - ▶ Rendezvous-Point-based shared distribution tree
- ▶ Overlay structure adaptive to node capacities
- ▶ Landmark signatures to map proximity into key space
- ▶ Dynamic, passive replication scheme for reliable multicast distribution
- ▶ Two-tier approach:
 - ES Multicast Management
 - P2P Network Management



PeerCast: P2P Management

- ▶ Proximity-aware DHT using landmarking
 - ▶ Landmark signature generated from distances to fixed landmark nodes
 - ▶ Landmark signature then substitutes a substring of each key identifier at the same "Splice Offset"
 - ▶ Neighbouring peers then clustered into "buckets"
- ▶ Accounting for node capabilities
 - ▶ Each node generates a multitude of keys, thus encountering multiple presence in the DHT ring
 - ▶ Key quantities are chosen according to node capabilities



PeerCast: ES Multicast Management

- Rendezvous Node chosen as group key owner
- Shared tree created according to reverse path forwarding
- Improvement – **Neighbour Lookup:**
 - Subscribers + forwarders check their neighbours prior to forwarding subscription request
 - If any neighbour has already joined the group, a 'shortcut' is taken

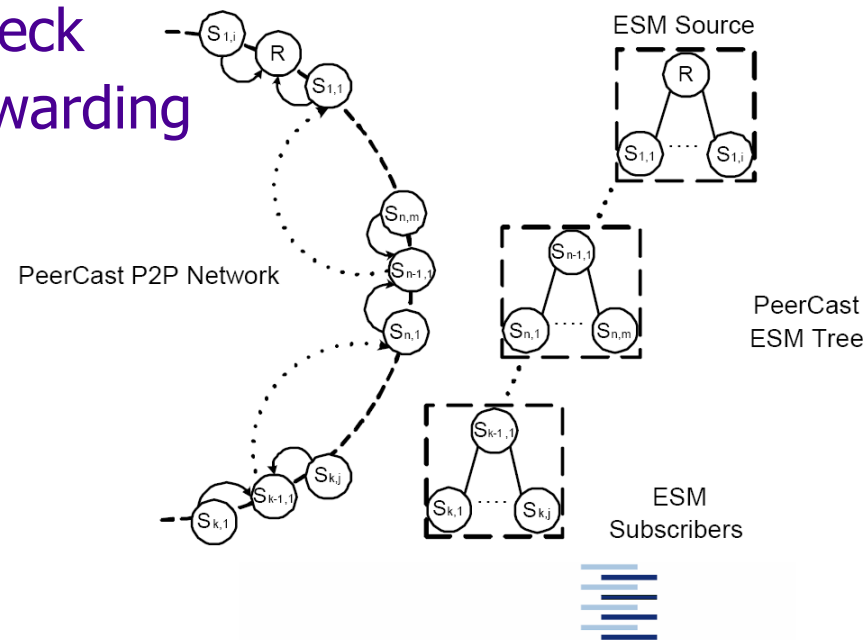

Performance of PeerCast

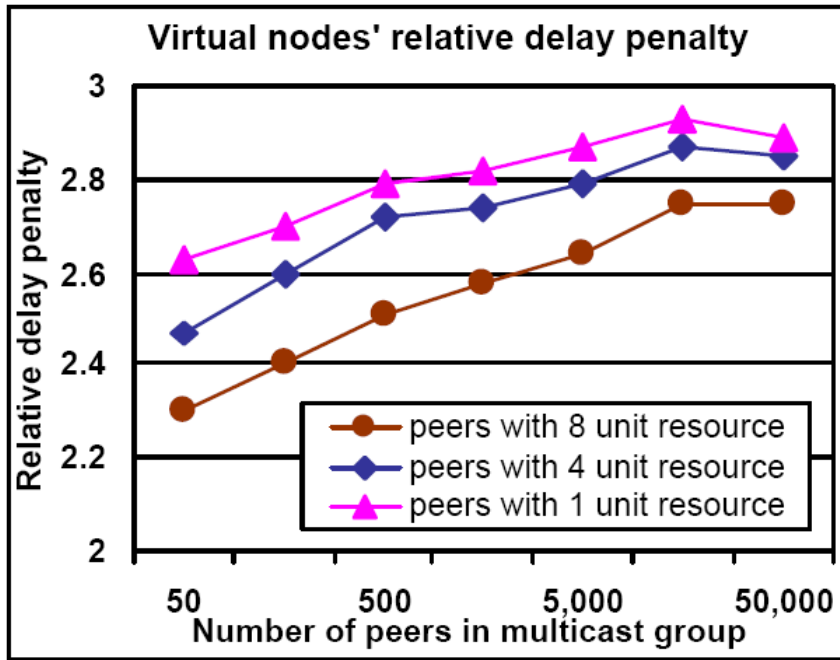

Figure 17: Relative delay penalty, $r = 8$
peers number = 50,000

r is heterogeneity measure

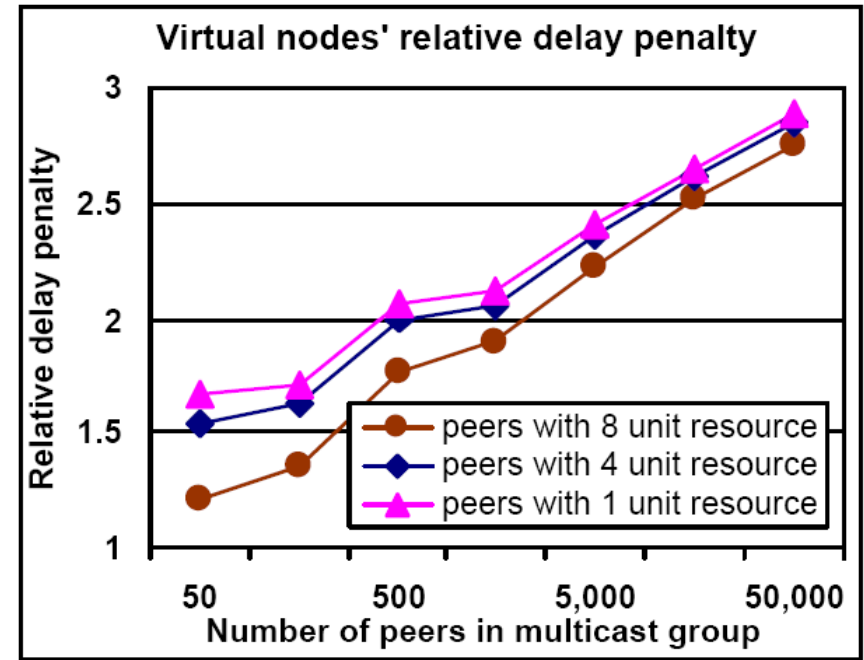

Figure 18: Relative delay penalty, $r = 8$
peers number = multicast group size



Summary on PeerCast

- ▶ Interesting optimization of structured multicast
 - ▶ Introduces node capacity and neighborhood shortcuts

PROs

- ▶ Improved ways of adaptation

CONs

- ▶ Distribution trees still detour the RP triangle and use RPF at asymmetric unicast routing
- ▶ Unstable delay and jitter values



Source Specific Distribution Tree: Bayeux (Zhuang et al, 2001)

- Based on Tapestry
- Creates a group by placing an empty file named by the hashed group ID
 - ▶ Announced by Tapestry location service
- Receivers learn about group ID and perform source-specific subscriptions
- Subscriptions are routed to the owner of the file, acting as the source & central controller
- Source (and intermediate branch nodes) perform full receiver tracking



Bayeux Group Management

- Distribution tree is built according to (forward) pushed TREE messages

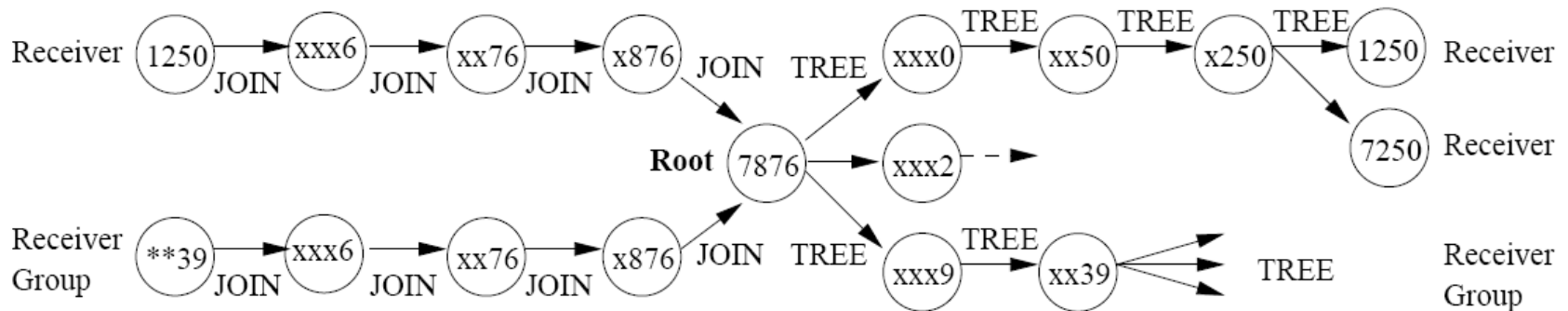

- Leaves are routed to the source and trigger a PRUNE message



Bayeux Performance

- ▶ Bayeux suffers from scaling problems due to the central controller
- ▶ Improvements are proposed to cluster receivers (hybrid) and to replicate via several roots

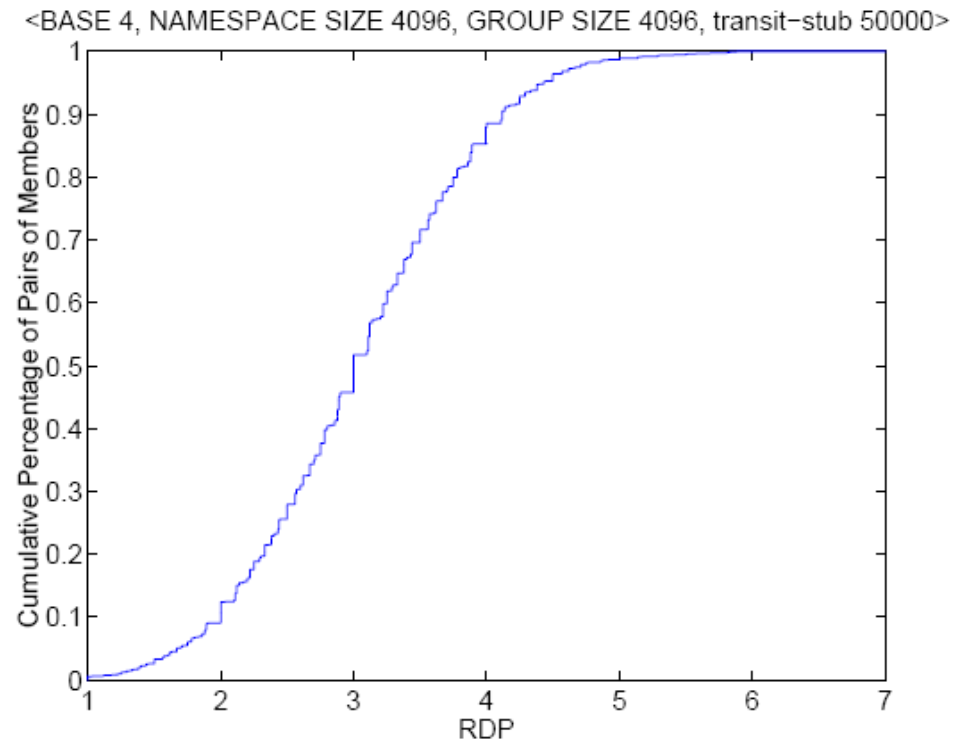

Bidirectional Scalable Adaptive Multicast - BIDIR-SAM (Wählisch et al. 2007)

- Idea to build multicast in the key-based routing layer: Group distribution in a prefix overlay (on top of KBR)
- Nodes are represented in prefix trees (analogue to prefix flooding)
- Group management: State dissemination in prefix space
- Constructs source-specific shared trees (like Nice)

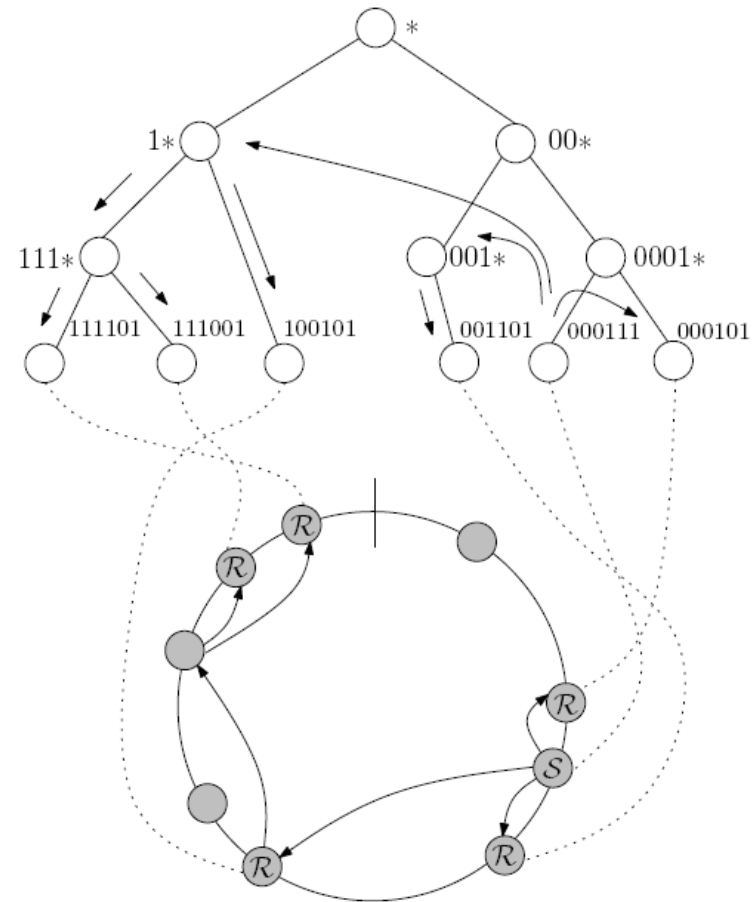

Group Management

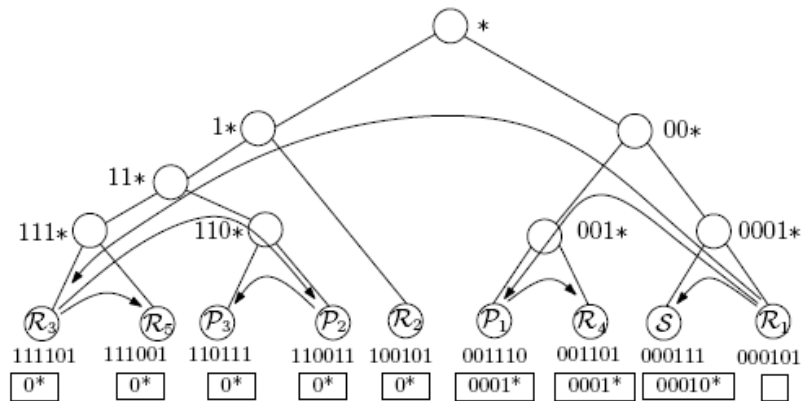

(a) \mathcal{R}_1 joins G

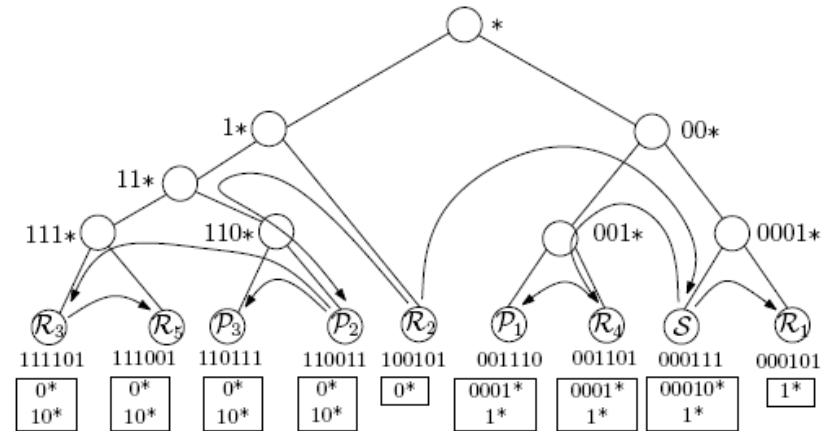

(b) \mathcal{R}_2 joins G

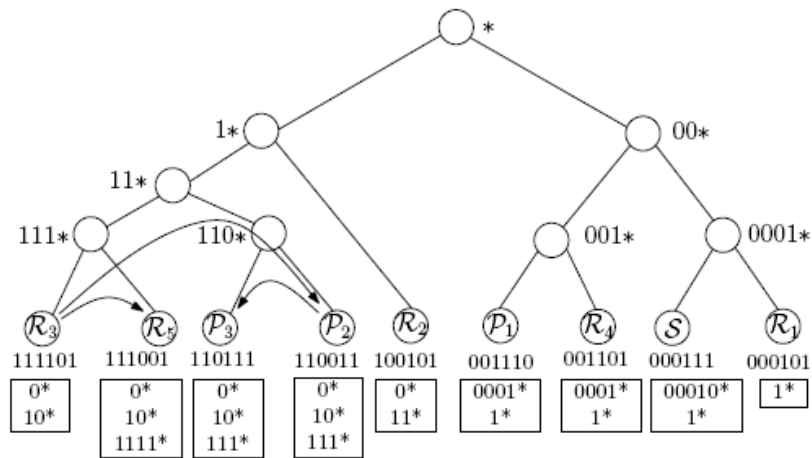

(c) \mathcal{R}_3 joins G

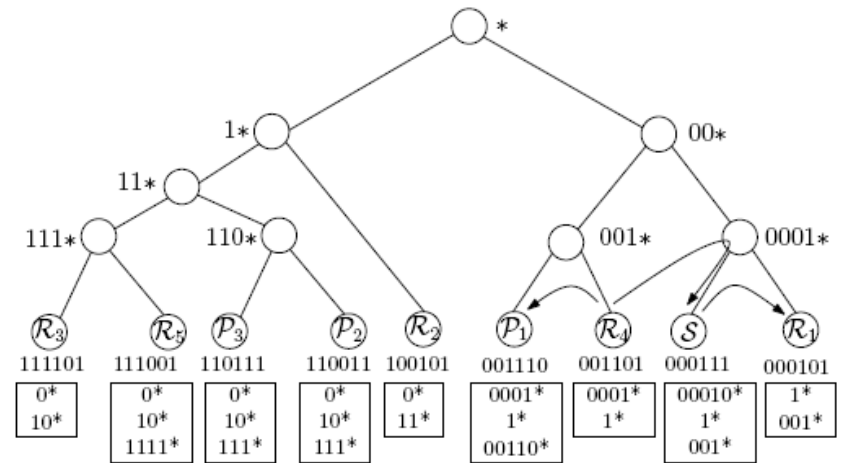

(d) \mathcal{R}_4 joins G

Forwarding Along Virtual Prefix Tree

BIDIR-SAM FORWARDING

- ▷ On arrival of packet with destination prefix \mathcal{C}
- ▷ for group G at DHT node of ID \mathcal{K}
- 1 **for** all \mathcal{N}_i IDs in MFT_G
- 2 **do if** $LCP(\mathcal{C}, \mathcal{N}_i) = \mathcal{C}$
 - ▷ \mathcal{N}_i is dountree neighbor
- 3 **then** $\mathcal{C}_{new} \leftarrow \mathcal{N}_i$
- 4 FORWARD PACKET TO \mathcal{C}_{new}



BIDIR-SAM Performance

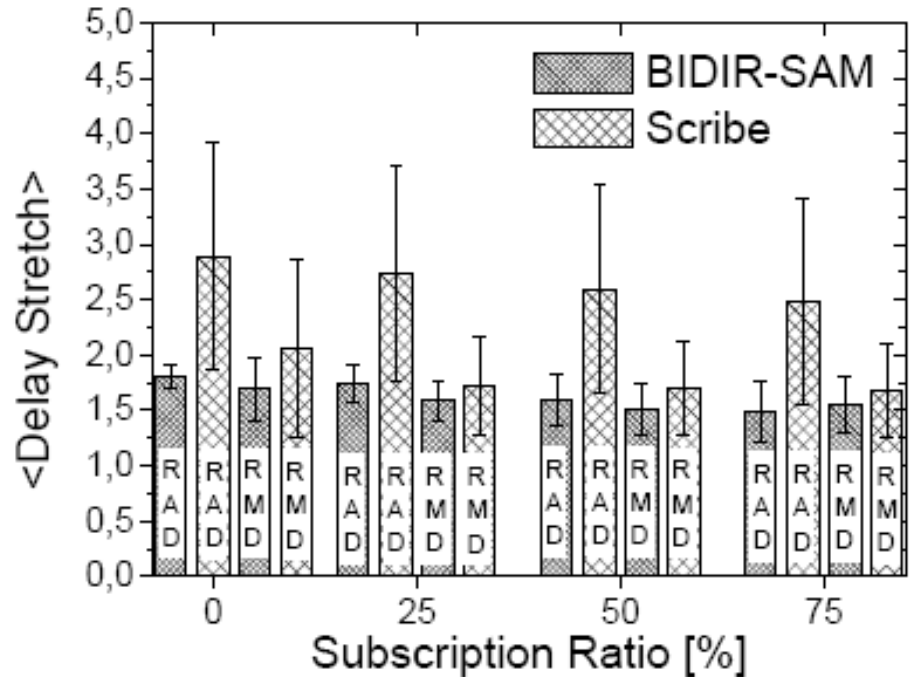
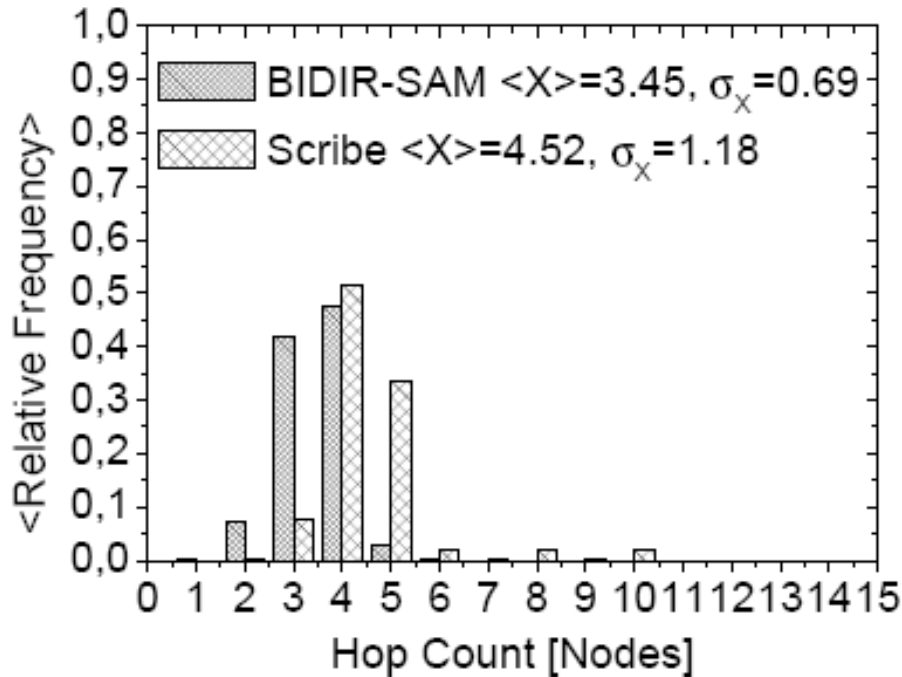

BIDIR-SAM Performance

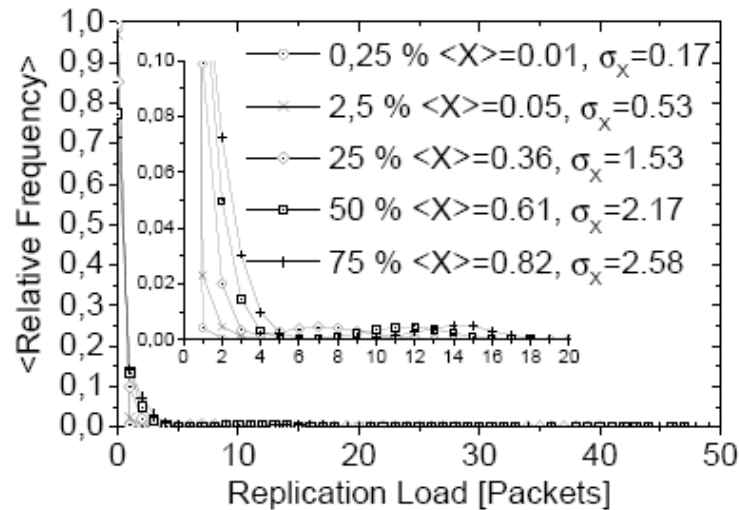

(a) BIDIR-SAM

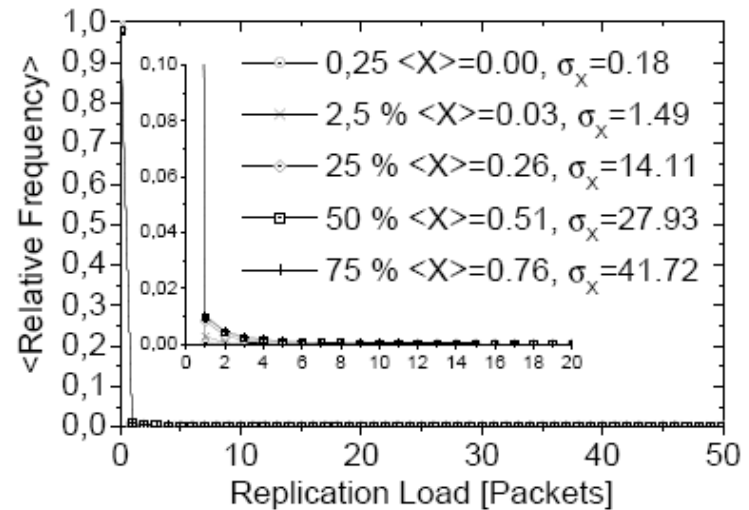

(b) Scribe

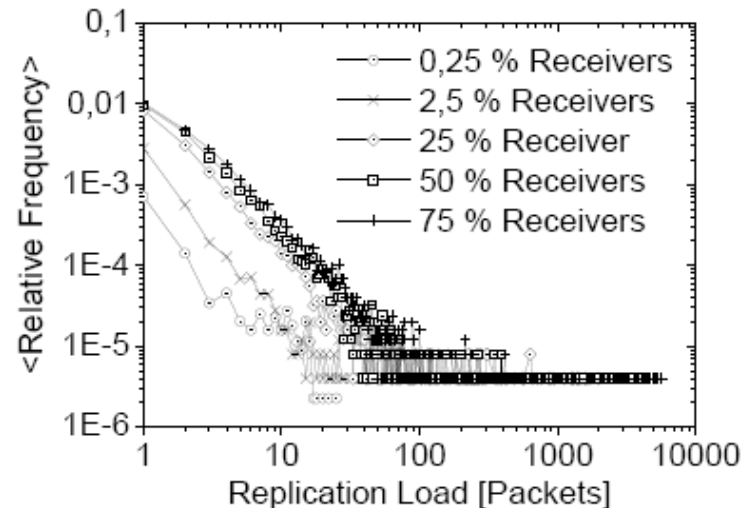
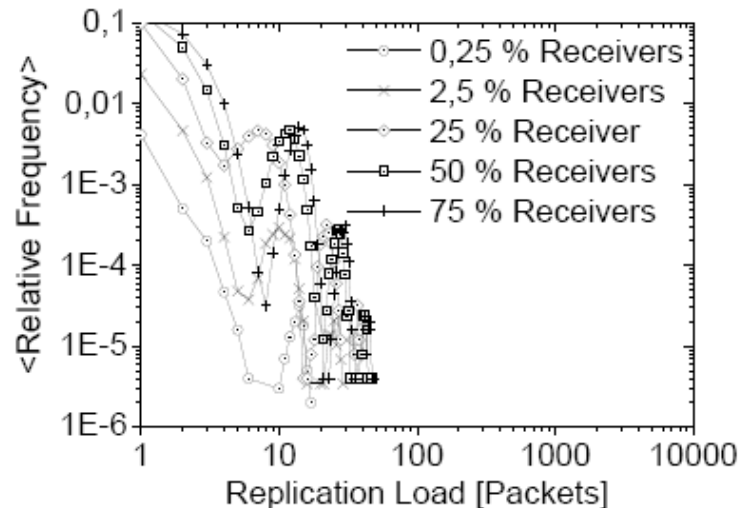

Large-scale Measurements: Globally Distributed Delay Space

(a) One-Way Average Delays

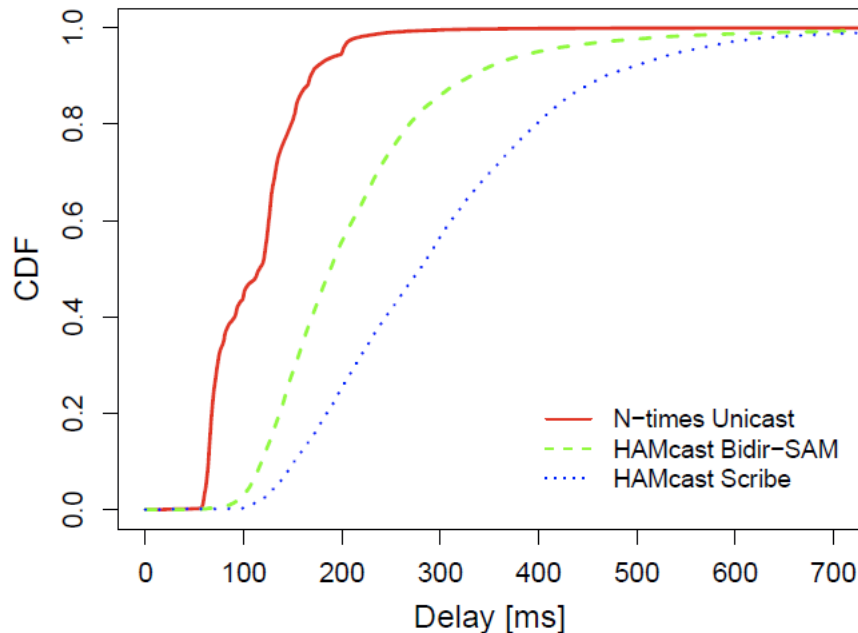

(b) One-Way Maximum Delays

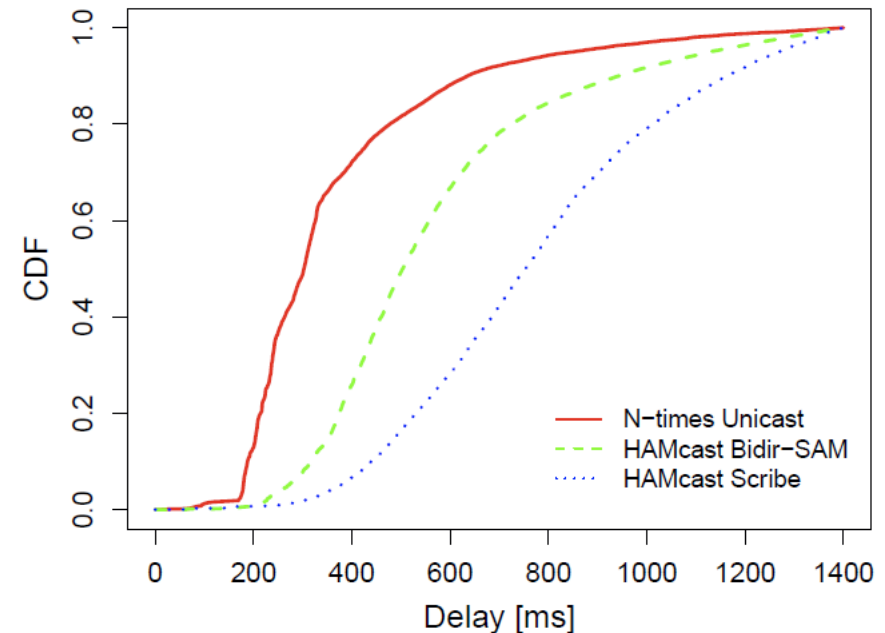

► 250 Nodes in Planet-Lab on all continents



Large-scale Measurements (cont.)

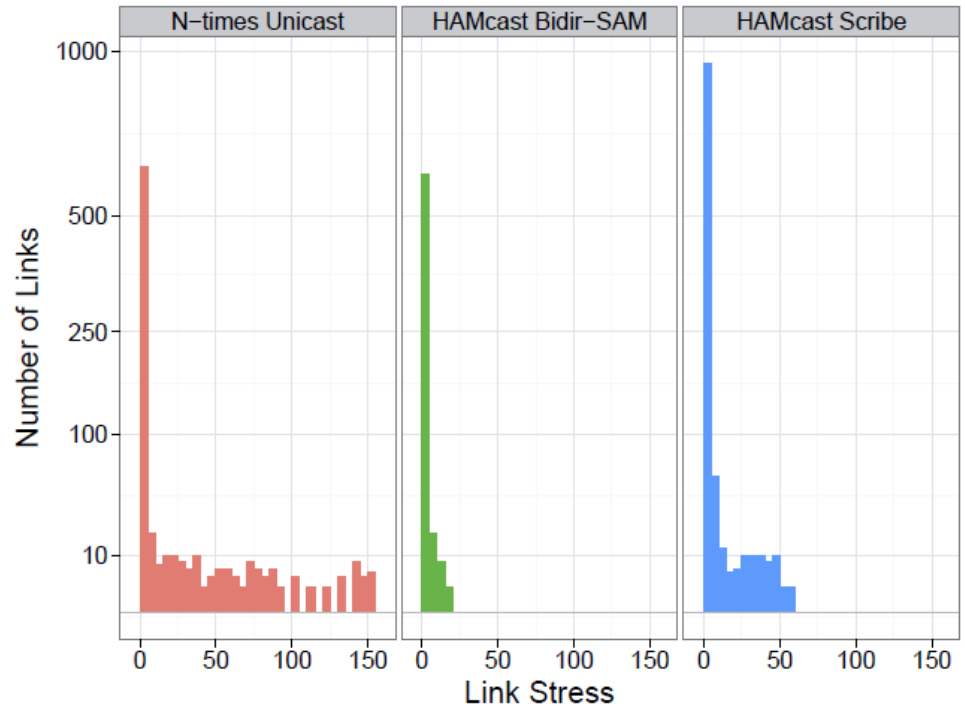

Additional Design Mechanisms

Two core problems arise in wide-area broadcast/multicast distribution:

- ▶ Reliability and redundancy without retransmission
 - ▶ In particular for file distribution: all blocks are needed
 - ▶ Promising approach: Network Coding
- ▶ Flow control / flow adaptation in heterogeneous environments
 - ▶ Data streams may meet network bottlenecks
 - ▶ Promising approach: Selective dropping after Backpressure Control



Network Coding (Li, Yeung, Cai, 2003)

- Original idea: network efficiency can be enhanced by linear combination of packets
- Useful in Wireless transmission to enhance efficiency
- In Overlay Multicast mainly to add ,universal' redundancy

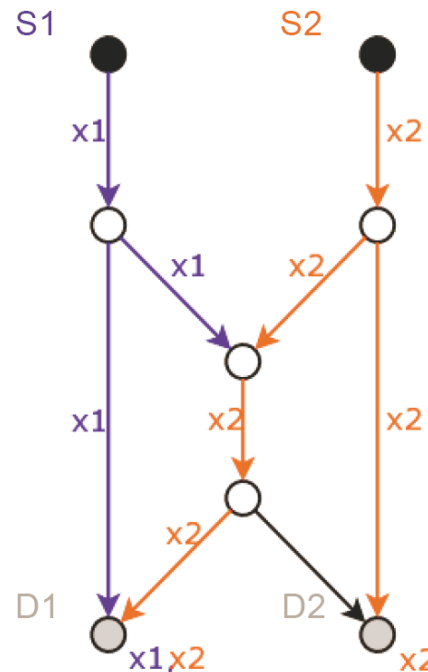

Max. broadcast rate = 1.5

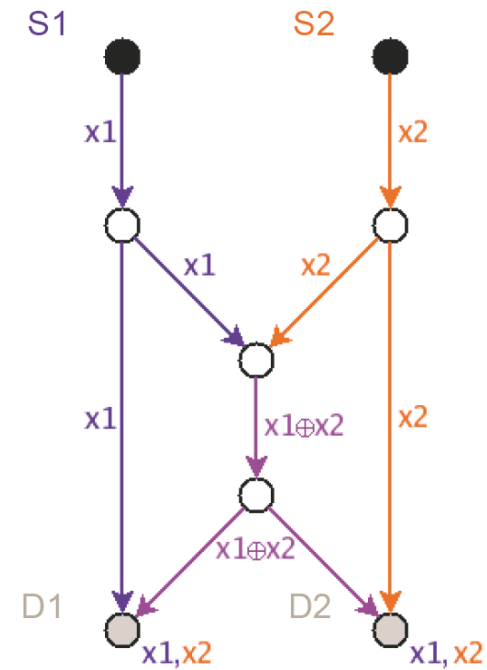

Max. broadcast rate = 2

Network Coding Simplified

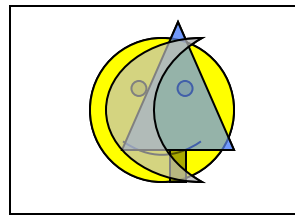

Encoding

Block 1

Block 2

Block 3

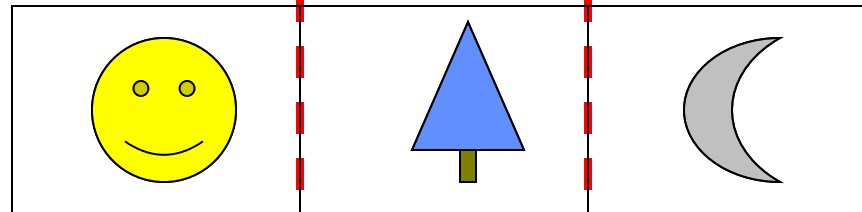

File to Transfer

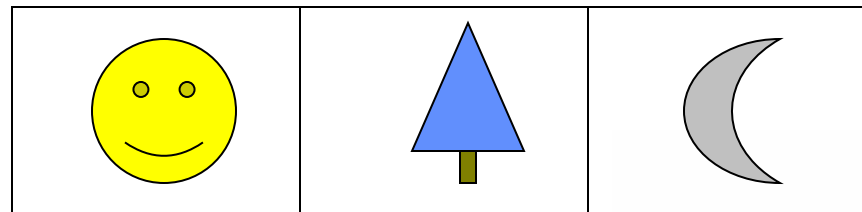
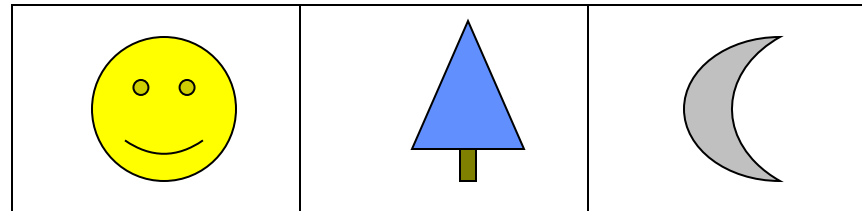

With Network Coding

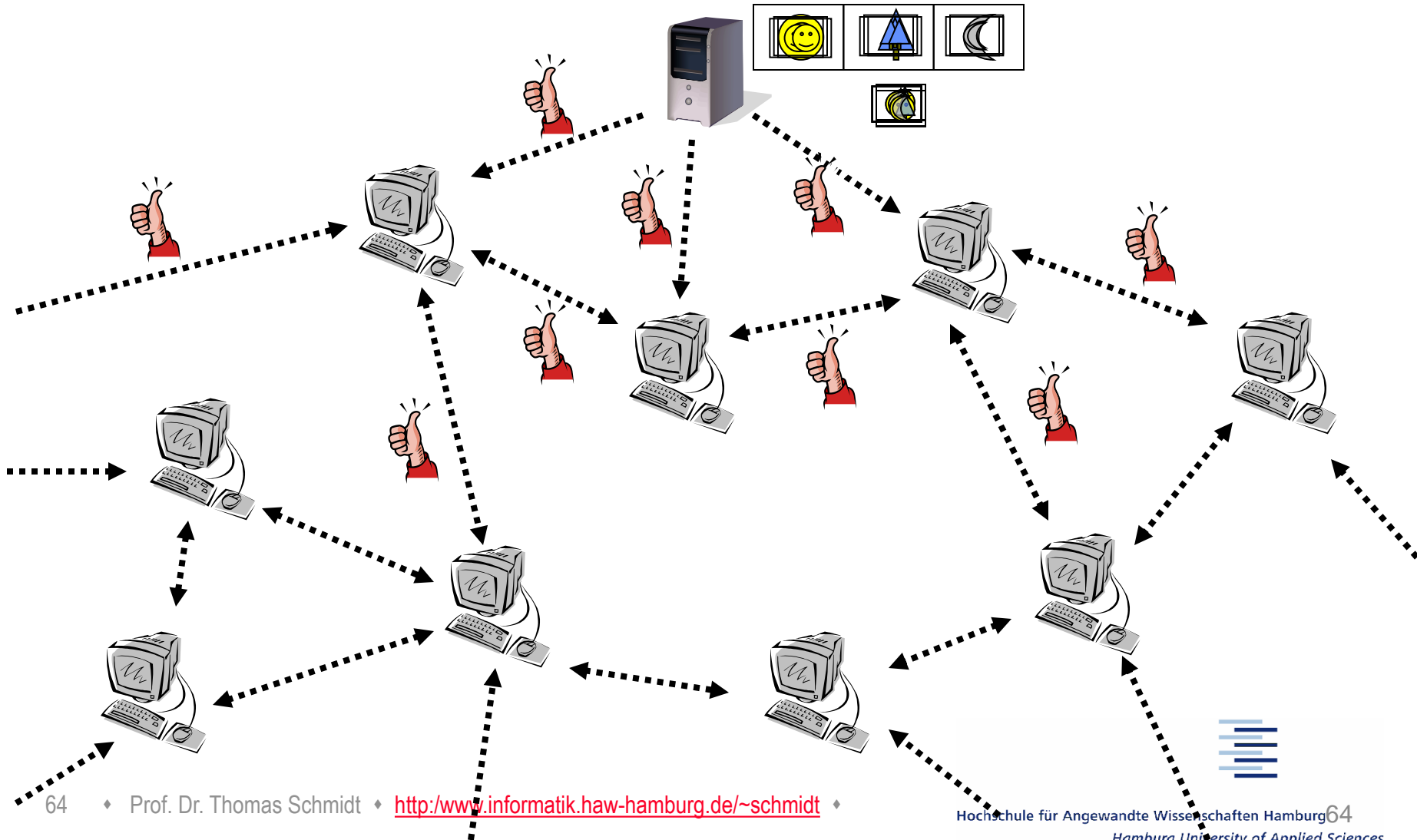

Problem of Flow Control

- ▶ In a distribution system (e.g., Tree) there may occur at some part
 - ▶ Heterogeneous link transitions
 - ▶ Congestions
 - ▶ Fluctuating link conditions
- ▶ Problems
 - ▶ Long-range (e.g., receiver) feedback prevents scaling
 - ▶ How to decide locally on efficient flow forwarding (omit forwarding packets that are discarded later)?



Group Distribution without Flow Control

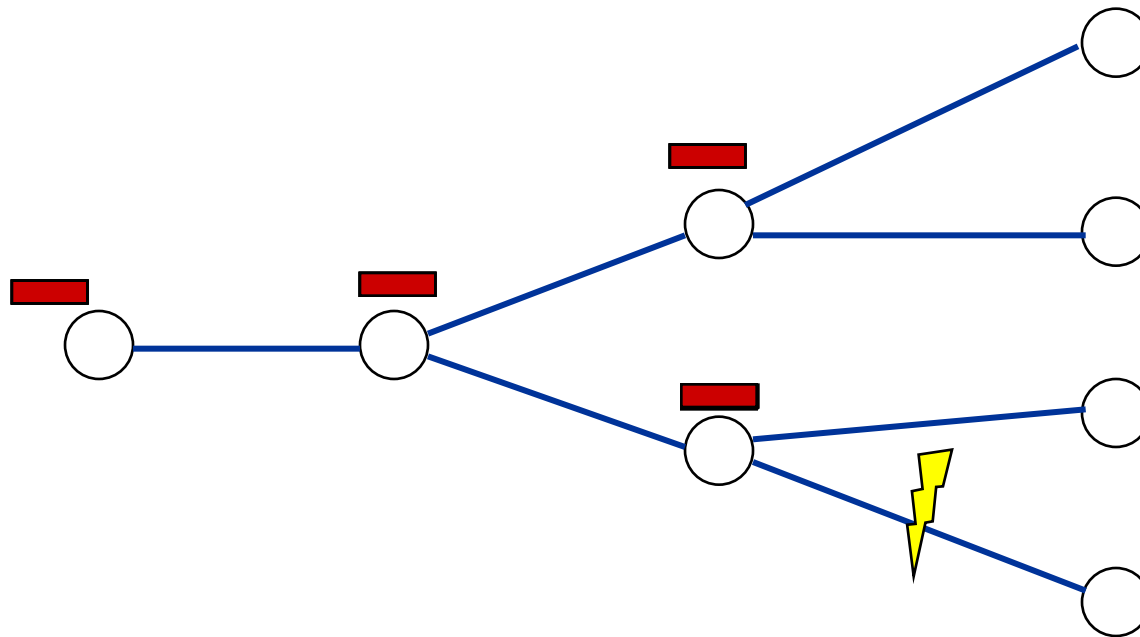

Backpressure Multicast: Simple Flow Control

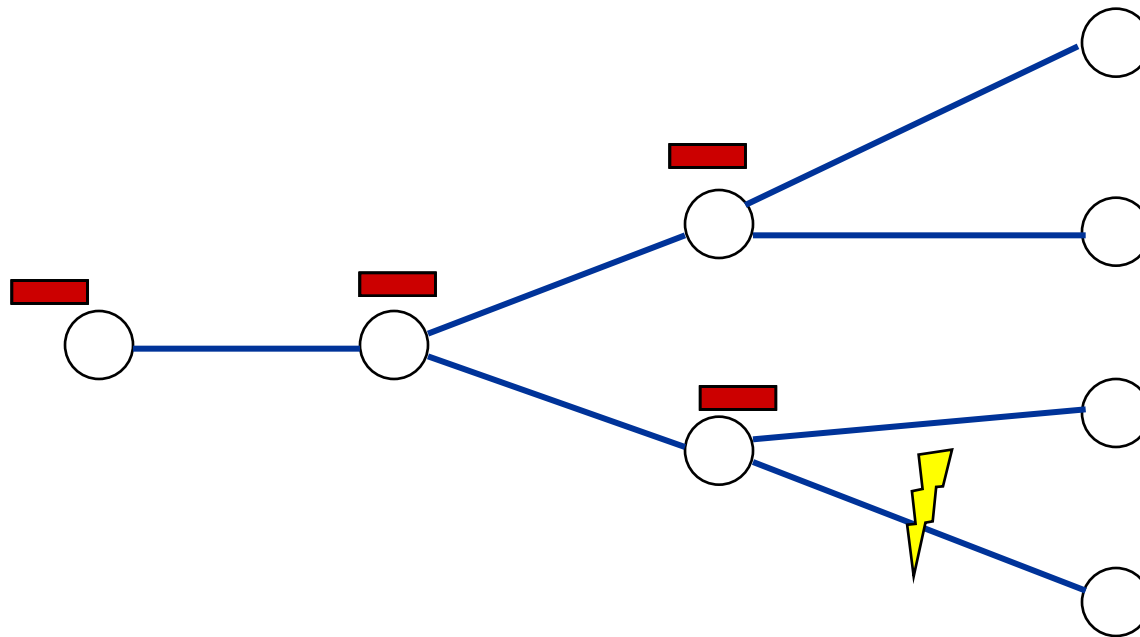

- Intermediate Node can decide about dropping or delaying



Programming: Unique Interface

RFC 7046

► Send and receive calls

```
createMSocket(out SocketHandle h, [in enum Interface  
i])
```

```
join(in SocketHandle h, in URI g, [in Interface i])
```

```
leave(in SocketHandle h, in URI g, [in Interface i])
```

```
srcRegister(in SocketHandle h, in URI g, [out  
Interface i])
```

```
send(in SocketHandle h, in URI g, in Message msg)
```

```
receive(in SocketHandle h, out URI g, out Message  
msg)
```

► Service calls

► Socket option calls

URI-based Naming Scheme

**scheme "://" group "@" instantiation
":" port "/" sec-credentials**

- ▶ **scheme**: specification of assigned ID
- ▶ **group**: identifies the group
- ▶ **instantiation**: ID of the entity that generates the instance of the group (SSM source, RP, overlay node)
- ▶ **port**: ID of a specific application at a group instance
- ▶ **sec-credentials**: optional authentication

Examples:

ham:opaque:news@cnn.com/auth-value

ham:ip:224.10.20.30@1.2.3.4:5000/groupkey



Research Issues

- ▶ Joined / combined / hybrid solutions for a global group communication layer
- ▶ Redundancy & robustness enhancements by Network Coding
- ▶ Multipath transport without jitter explosion
- ▶ Proximity under mobility – Constructions of distributions trees efficient w.r.t. the underlay topology
- ▶ Stability under mobility – Construction of efficient multicast distribution trees, which are robust
- ▶ QoS improvements & flow control, measures and guaranties to provide real-time capabilities
- ▶ Security & Robustness against malicious node behaviour

References

- K. Katrinis, M. May: *Application-Layer Multicast*, in Springer LNCS 3485, 2005.
- Y. Chu, S. G. Rao, and H. Zhang: *A Case for End System Multicast*, Proceedings of ACM SIGMETRICS, Santa Clara, CA, June 2000.
- S. Banerjee, B. Bhattacharjee, C. Kommareddy: *Scalable Application Layer Multicast*, SIGCOMM Pittsburgh, PA 2002.
- S. Ratnasamy, M. Handley, R. Karp, S. Schenker: *Application-Level Multicast using Content-Addressable Networks*, Proc. 3rd Intern. Workshop on Networked Comm., London, Nov. 2001.
- M. Castro, P. Druschel, A. Kermarrec, A. Rowstron: *SCRIBE: A large-scale and decentralized application-level multicast infrastructure*, IEEE Journ. Select. Areas in Comm., 20 (8), Oct 2002.
- M. Castro, P. Druschel, A-M. Kermarrec, A. Nandi, A. Rowstron and A. Singh: *SplitStream: High-bandwidth multicast in a cooperative environment*, SOSP'03, Lake Bolton, New York, October, 2003.
- J. Zhang, L. Liu, C. Pu, M. Ammar: *Reliable End System Multicast with a Heterogeneous Overlay Network*. CERCS Technical Report git-cercs-04-19, Georgia Institute of Technology, April 2004.



References

- S. Q. Zhuang, B. Y. Zhao, A. D. Joseph, R. H. Katz, and J. D. Kubiatowicz: *Bayeux: An Architecture for Scalable and Fault-tolerant Wide-Area Data Dissemination*, in NOSSDAV '01: ACM, 2001, pp. 11-20
- M. Wählisch, T. C. Schmidt, G. Wittenburg: *BIDIR-SAM: Large-Scale Content Distribution in Structured Overlay Networks*, Proc. of the 34th IEEE Conference on Local Computer Networks (LCN), pp 372—375, IEEE Press, October 2009.
- M. Wählisch, T. C. Schmidt, G. Wittenburg: *On Predictable Large-Scale Data Delivery in Prefix-based Virtualized Content Networks*, Computer Networks, 55 (2011) 4086–4100.
- M. Wählisch, T. C. Schmidt: *Multicast Routing in Structured Overlays and Hybrid Networks*, in Shen, Yu, Buford: *Handbook of Peer-to-Peer Networking*, pp. 897--932, Springer, January 2010.
- S. Meiling, T. C. Schmidt, M. Wählisch: *Large-Scale Measurement and Analysis of One-Way Delay in Hybrid Multicast Networks*, Proc. of the 37th IEEE Conference on Local Computer Networks (LCN), IEEE Press, October 2012.
- M. Wählisch, T. C. Schmidt, S. Venaas: *A Common API for Transparent Hybrid Multicast*, RFC 7046, December 2013.